



X
SERIES

X SERIES OWNERS MANUAL

bullfrog[®]
spas

QUICK REFERENCE

To assist you with the installation and maintenance service of your new spa, please fill out the following information and keep it on hand for future reference.

My Spa Information

Model: _____

Serial Number: _____

Dealership: _____

Dealer's Phone Number: _____

Date Purchased: _____

Date Installed: _____

Contractor Information

General

1. Name: _____

Telephone: _____

2. Name: _____

Telephone: _____

Electrician

1. Name: _____

Telephone: _____

2. Name: _____

Telephone: _____

Concrete, Decking, and Masonry

1. Name: _____

Telephone: _____

2. Name: _____

Telephone: _____

Landscaping

1. Name: _____

Telephone: _____

2. Name: _____

Telephone: _____



TABLE OF CONTENTS

Quick Reference	1
Overview	3
Important Safety Instructions	4
Getting to Know Your Spa	7
Filling Your Spa	9
X Series Control Panels	10
Water Care & Chemistry	17
Spa Maintenance	19
Installation & Delivery	24
Setup & Wiring Diagrams	29
GFCI Wiring Diagram	31
RCD Wiring Diagram	32
Troubleshooting Guide	33
Warranty Info	34





Congratulations on your purchase of a Bullfrog Spas X Series hot tub.

NOTE: In this document, the terms “Spa” and “Hot Tub” are used interchangeably. Take a moment to read this manual carefully. Following the instructions in this manual will ensure the safe and smooth operation of your new spa.

Carefully read this Owner’s Manual before you install your spa. Your Bullfrog Spas Limited Warranty may be voided if damage is caused by failure to install, maintain, and operate your spa in accordance with the recommendations contained in this Owner’s Manual or any other printed instruction, notice or bulletin from Bullfrog Spas. Your spa’s serial number is located both on the base under the equipment door and the Manufacturing ID Label located inside the equipment compartment of your spa.

For the safety of all those who utilize your spa and its surroundings, please make sure your spa and any adjoining installations, including the electrical hook-up, are completed according to codes of and only after acquiring any necessary approvals and permits from your local, state/provincial, and/or national government. Follow all local, state, and national safety and wiring rules. Some jurisdictions require certain fencing and/or self-closing and self-latching gates to prevent accidental drowning in a pool or spa. Your spa cover comes with a locking system that meets the ASTM F1346-91 Standard for Safety Covers, which when properly used, may satisfy certain fencing

and gating requirements. Your spa meets or exceeds all requirements of the Virginia Graeme Baker Pool and Spa Safety Act. Your spa has been tested and either meets or exceeds the UL-1563 portable spa standard.



U.S. Patents: 7,908,684, 8,661,576, 8,881,321, 8,689,370, 8,869,469, 5,754,989, 5,987,663, 6,000,073, 6,092,246, 6,256,805, 6,543,067
New Zealand Patent: 555112, 334,093
Australia Patent: 737,335
Canada Patents: 2,588,884, 2,260,237, 2,915,184
 Other patents pending worldwide

X Series spas include the following models: X8, X8L, X7, X7L, X6L, X5L, & X6R

Bullfrog Spas reserves the right to change features, specifications & design without notification and without incurring any obligation.

Help us ensure the very best hot tub ownership experience by registering your warranty. Use the QR code or this link to register: bullfrogspas.com/warranty-registration.



SPA REGISTRATION

IMPORTANT SAFETY INSTRUCTIONS

Safety Instructions

When installing and using this electrical equipment, basic safety precautions should always be taken, including the following:

Read and follow all instructions:

▲ **WARNING:** To reduce the risk of injury, do not permit children to use this product unless closely supervised at all times.

As per UL requirements (U.S.), a wire connector is provided on this unit to connect a minimum No. 8 AWG (8.4mm²) solid copper conductor between this unit and any metal equipment, metal enclosures of electrical equipment, metal water pipe, or conduit within 5 feet (1.5m) of the unit.

▲ **WARNING:** For products provided with a cord-connected, ground-fault circuit-interrupter, the GFCI must be tested before each use. If the GFCI fails to operate properly, disconnect the power until the fault has been identified and corrected.

▲ **DANGER:** Risk of Accidental Drowning. Extreme caution must be exercised to prevent unauthorized access by children. To avoid accidents, ensure that children cannot use this spa unless they are supervised at all times.

▲ **DANGER:** Risk of Injury. The suction fittings in the spa are sized to match the specific water flow created by the pump. Should the need arise to replace the suction fittings or the pump, be sure that the flow rates are compatible. Never operate the spa if the suction fittings are broken or missing. Do not replace a suction fitting with one rated less than the flow rate marked on the original suction fitting.

▲ **DANGER:** Risk of Electric Shock. As per UL requirements (U.S.), install spa at least 5 feet (1.5m) from all metal surfaces. A spa may be installed within 5 feet (1.5m) of metal surfaces if each metal surface is permanently connected by a minimum of No. 8 AWG (8.4mm²) solid copper conductor to the wire connector on the terminal box that is provided for this purpose.

▲ **DANGER:** Risk of Electric Shock. Do not permit any electrical appliances, such as a light, telephone, radio, or television, within 5 feet (1.5m) of the spa. These units DO NOT have an integral ground fault circuit interrupter. The installation of an integral ground fault circuit interrupter MUST be completed by a qualified Electrician and must meet all applicable electrical codes.

For Cord-Connected units:

Replace the damaged cord immediately.
Do not bury the cord.

Connect to grounded, grounding-type receptacle only.

▲ **WARNING:** To Reduce the Risk of Injury:

Water temperature in a spa should never exceed 104°F (40°C). Water temperatures between 100°F (38°C) and 104°F (40°C) are considered safe for a healthy adult. Water temperature in excess of 104°F (40°C) may be harmful to your health. Lower temperatures are recommended for young children and/or when spa use exceeds 10 minutes.

High temperatures could have the potential for causing fetal damage during pregnancy. Pregnant women or women that could be pregnant should consult a physician and possibly limit spa usage when temperatures are in excess of 100°F (38°C).

Before entering the spa, measure the water temperature with an accurate thermometer since tolerances of water temperature regulating devices may vary.

Use of alcohol, drugs, or medication before or during spa use may lead to unconsciousness with the possibility of drowning.

Persons suffering from obesity or a medical history of heart disease, low or high blood pressure, circulatory system problems, and/or diabetes should consult a physician before using a spa.

Persons using medication should consult a physician before using a spa. Some medications may induce drowsiness while other medication may affect heart rate, blood pressure, and/or circulation.

▲ **WARNING:** PEOPLE WITH INFECTIOUS DISEASES SHOULD NOT USE A SPA OR HOT TUB.

▲ **WARNING:** TO AVOID INJURY, EXERCISE CARE WHEN ENTERING OR EXITING THE SPA OR HOT TUB. NEVER DIVE OR JUMP INTO THE SPA.

▲ **WARNING:** DO NOT USE A SPA OR HOT TUB IMMEDIATELY FOLLOWING STRENUOUS EXERCISE.

▲ **WARNING:** PROLONGED IMMERSION IN A SPA OR HOT TUB MAY BE HARMFUL TO YOUR HEALTH.

▲ **CAUTION:** MAINTAIN WATER CHEMISTRY IN ACCORDANCE WITH THE MANUFACTURER'S INSTRUCTIONS.

▲ **CAUTION:** ADEQUATE DRAINAGE MUST BE PROVIDED IF THE EQUIPMENT IS TO BE INSTALLED IN A SPAVAULT OR BELOW GROUND LEVEL.

▲ **WARNING:** Risk of Fatal Hypothermia. Hypothermia occurs when the internal temperature of the body reaches

a level several degrees above the normal body temperature of 98.6°F (37°C). The symptoms of Hypothermia include dizziness, lethargy, drowsiness, and fainting. The use of alcohol, drugs, and/or medication can greatly increase the risk of fatal Hypothermia.

The effects of Hypothermia include:

- Unawareness of impending hazard
- Failure to perceive heat
- Failure to recognize the need to exit the spa
- Physical inability to exit the spa
- Fetal damage in pregnant women
- Unconsciousness and danger of drowning

▲ WARNING: Risk of Children Drowning. Your spa cover is not rated as a safety cover. It is suggested to always keep the spa cover securely fastened when not in use. This will discourage children from attempting to enter the spa unsupervised. If cover is damaged it should be replaced.

▲ WARNING: Risk of Children Drowning. Your spa cover is not rated as a safety cover. It is suggested to always keep the spa cover securely fastened when not in use. This will discourage children from attempting to enter the spa unsupervised. If cover is damaged it should be replaced.

▲ WARNING: Risk of Drowning. Use caution when bathing alone. Overexposure may cause nausea, dizziness, and fainting.

▲ CAUTION: Risk of Injury. Young children should always be supervised so that they do not play in or around the spa.

▲ WARNING: Keep all glassware and other breakable objects away from the spa area.

▲ WARNING: Risk of Injury: Short-term inhalation of high concentrations of ozone and long-term inhalation of low concentrations of ozone can cause serious physiological effects.

▲ CAUTION: Unauthorized Access. Secure the spa area against unauthorized access. Make sure all spa barriers (fences, enclosures, etc.) meet all applicable national and local codes. Keep spa cover on and locked when it is not being used.

▲ CAUTION: Risk of Damage to Spa or Equipment. By performing maintenance as described in this manual, the chance of damage to your spa and its equipment will be reduced. Never block the air vents that lead to the spa's equipment compartment, doing so may cause the spa to overheat.

▲ WARNING: Risk of Electric Shock or Death. Do not operate spa during severe weather conditions (e.g. electrical storms, tornadoes, etc.).

▲ CAUTION: Non-Approved Accessories. Using accessories not approved by Bullfrog International, LC could void your warranty or cause other problems. Please

consult your authorized Bullfrog Spa dealer.

▲ CAUTION: Spa Location. Locate your spa on a foundation that can support the maximum filled weight of your spa along with the weight of all the occupants using the spa (see Site Selection and Preparation). Also, locate your spa in an environment that can withstand repeated exposure to water and the possibility of a major spill.

▲ CAUTION: Power cords must be replaced only with a special cord assembly available from the Manufacturer, its Service Agent, or similarly qualified persons in order to avoid a hazard.

▲ WARNING: This appliance is not intended for use by young children or unhealthy people without supervision.

▲ WARNING: Before obtaining access to supply terminals, all supply circuits must be disconnected.

▲ WARNING: Risk of Injury or Accidental Drowning: Do not use spa without filters, filter plate, and filter SnapCaps™ installed; these parts serve as a barrier against bodily entrapment against the filter suction fitting(s).

▲ CAUTION: Test the GFCI or RCD (Residual Current Device) before each use of the spa.

▲ WARNING: Spas equipped with JetPaks are intended to operate with all JetPaks. Do not operate spa without all JetPaks, pillows, and snapcaps securely in place.

▲ WARNING: Risk to Infants, Elderly, and Women Planning or Experiencing Pregnancy. Please consult your physician if the above applies to you or anyone using the spa

Additional Instructions (Canadian Installations Only):

A green-colored terminal or a terminal marked G, GR, Ground, Grounding or the international grounding symbol is located inside the supply terminal box or compartment. To reduce the risk of electric shock, this terminal must be connected to the grounding means provided in the electric supply service panel with a continuous copper wire equivalent in size to the circuit conductors supplying this equipment.

At least two lugs marked "BONDING LUGS" are provided on the external surface or on the inside of the supply terminal box or compartment. To reduce the risk of electric shock, connect the local common bonding grid in the area of the spa or hot tub to these terminals with an insulated or bare copper conductor no smaller than No. 6 AWG.

All field-installed metal components such as rails, ladders, drains, or other similar hardware located within 10 feet (3m) of the spa or hot tub must be bonded to the equipment grounding bus with copper conductors no smaller than No. 6 AWG.

Warning Signs (North America)

Included with the spa is a warning sign to inform users and guests of the risks involved with using a spa. This sign is suitable for indoor and outdoor use. It should be placed in a noticeable place adjacent to the spa. For free additional copies, contact your authorized Bullfrog Spa Dealer.

* Final warning sticker is included with spa for installation by owner.



THIS MARKING IS TO BE REMOVED ONLY BY THE OWNER AFTER SAFETY SIGN IS INSTALLED **69.1-S**

1. REDUCE THE RISK OF ELECTROCUTION

NEVER PLACE AN ELECTRIC APPLIANCE WITHIN 5 FEET OF SPA

2. REDUCE THE RISK OF CHILD DROWNING

SUPERVISE CHILDREN AT ALL TIMES.

ATTACH SPA COVER AFTER EACH USE.

3. REDUCE THE RISK OF OVERHEATING

CHECK WITH A DOCTOR BEFORE EACH USE IF PREGNANT, DIABETIC, IN POOR HEALTH, OR UNDER MEDICAL CARE.

EXIT IMMEDIATELY IF UNCOMFORTABLE, DIZZY, OR SLEEPY. SPA HEAT CAN CAUSE HYPOTHERMIA AND UNCONSCIOUSNESS

SPA HEAT IN CONJUNCTION WITH ALCOHOL, DRUGS, OR MEDICATION CAN CAUSE UNCONSCIOUSNESS.

WHEN PREGNANT, SOAKING IN HOT WATER FOR LONG PERIODS CAN HARM YOUR FETUS.

MEASURE WATER TEMPERATURE BEFORE ENTERING.

DO NOT ENTER SPA IF WATER IS HOTTER THAN 100 °F (38 °C)

DO NOT STAY IN SPA FOR LONGER THAN 10 MINUTES. **70.1-0**

DO NOT INSTALL THE SPA UNDER A SPA SKIRT OR WITHIN AN ENCLOSURE THAT WOULD RESTRICT VENTILATION.

IF A BLOWER IS INCLUDED, INSTALL AT LEAST 1 FOOT ABOVE THE MAXIMUM WATER LEVEL.

INSTALL A SUCTION GUARD WITH MARKED FLOW RATE NO LESS THAN ___ GPM TO AVOID HAIR & BODY ENTRAPMENT.

GETTING TO KNOW YOUR SPA

Spa Overview

(X7 Spa Model Pictured)



1. Main control (touch-screen upgrade optional)
2. Filter access
3. Headrest
4. Water feature
5. Foot therapy jet
6. Leg therapy jets
7. Main LED light
8. Entry step and cool-down seat
9. Floor drain
10. Ozone jet
11. Under headrest LED lighting
12. In-wall therapy jets
13. Filter intake
14. Diverter Valves
15. Air Valves

Equipment Compartment Overview

Spa Equipment Compartment "A8L" Series



1. Jet pump 1
2. Jet pump 2
3. Control center box
4. EOS ozone generator box
5. EOS mixing module
6. Safety certificate and serial number
7. Serial number sticker (visible with door installed)
8. Drain outlet
9. Water heater
10. Support stud
11. Cabinet attachment notch in support stud
12. ABS spa base pan
13. Audio control box
14. Acrylic spa shell

FILLING YOUR SPA

⚠ WARNING: An empty spa (spa without water in it) must not be left exposed to sunlight as shell damage may occur. Once the spa is unwrapped, fill the spa with water immediately or shade the spa with cover to prevent direct exposure to sunlight.

IMPORTANT: Do not turn power on to the spa without water in the spa. Serious damage to the pump and heater may occur.

⚠ WARNING: Make sure power is off to your spa prior to following spa filling procedure. Failure to do so may result in serious injury.

Spa Filling Steps (X Series)

Step 1: Remove filter cover by lifting until snap fittings release.

Note: Images show spa with filter plate removed for clarity.

Step 2: Remove filter cap.



Step 3: Place garden hose inside the inner chamber of the filter cage.



IMPORTANT: Never fill the spa with soft water unless an appropriate mineral supplement is immediately added (see your authorized Bullfrog Spas Dealer). If your water is

extremely hard, it is preferable to either dilute the water's hardness by blending the water with water from a water softener, using a mineral filter, or by the addition of a special water softening chemical (see your authorized Bullfrog Spas Dealer).

Step 4: Fill to the water level indicator line located on the right side of the grill on the face of the filter plate assembly.



Step 5: Reinstall the filter cap(s) and filter snap cap.

Step 6: Check for leaks: After the spa is filled, check all fittings and equipment in the equipment compartment for signs of leakage before turning on the spa. Turn on the pump(s), and once again, check for leakage. If a leak is detected, tighten the fitting by hand. If the leak persists contact your authorized Bullfrog Spas Dealer.

Step 7: Install Cover: The spa cover comes with tie down straps and locking hardware that attaches the cover to the spa or decking. If your dealer did not install the cover, refer to the Cover Installation Instructions included with the cover.

Cover locks are an essential component for compliance with the ASTM F1346-91 safety standard for spa covers.

IMPORTANT: The spa cover is a critical feature in maintaining a safe and secure spa environment. In addition, keeping your spa covered when not in use is important for maintaining spa water at the desired temperature and saving energy. When the spa is not in use, always place the cover over the spa and secure it by pulling down on the cover strap, clicking the two sides of the cover clips together, and then locking each clip with the key provided. The cover should remain in place and locked at all times when not in use to prevent unauthorized entry and to prevent the wind from blowing it open inadvertently.

X SERIES SPA CONTROL PANELS



X Series Standard Control

Preparation and Filling

Fill the spa to its correct operating level. Be sure to open all valves and jets in the spa before filling to allow as much air as possible to escape from the system during the filling process. For details see “Filling your spa” section. After turning the power on at the main power panel, the control panel display will go through an initializing sequence. This sequence displays information regarding the configuration of the hot tub control. After a few seconds, your control will display the Home/Status screen which shows time, jet and light status, temperature status, operation mode, etc.

Power

Press any button to turn the keypad on. After 30 minutes without activity it will shut off.

Priming the Pumps

Pumps must be primed directly after filling to ensure the correct operation of your spa. After initial startup, verify that the home status screen appears on the panel. To prime the pumps, press the “Jets 1” button once to prime in low-speed. After the pump turns on and water is visibly flowing from the jets wait a few seconds and then press “Jets 1” again to initiate high-speed operation of Pump 1. The pump has primed when water is flowing from the jets. If your spa is equipped with a second jet pump repeat the priming process for Pump 2 by pressing the “Jets 2” button once to turn on low speed and then a second time to turn Pump 2 on high.

IMPORTANT: Pumps should not be allowed to run without priming (no water flowing out of the jets) for more than 2 minutes. Doing so may cause damage to the pump(s).

NOTE: Sometimes momentarily turning the pump off and on will help it to prime. Do not do this more than 5 times. If the pump(s) will not prime, shut off the power to the spa and call for service.

Once you have completed priming, the home status screen will display the set temperature. The system requires approximately 1-2 minutes of water flowing through the heater to determine and display the correct water temperature.

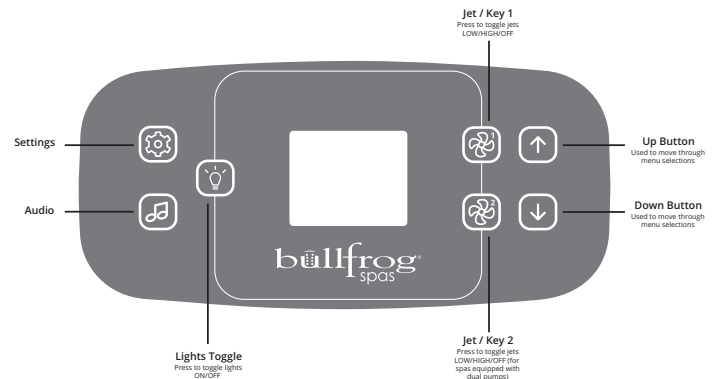

X Series Standard Control (with audio)

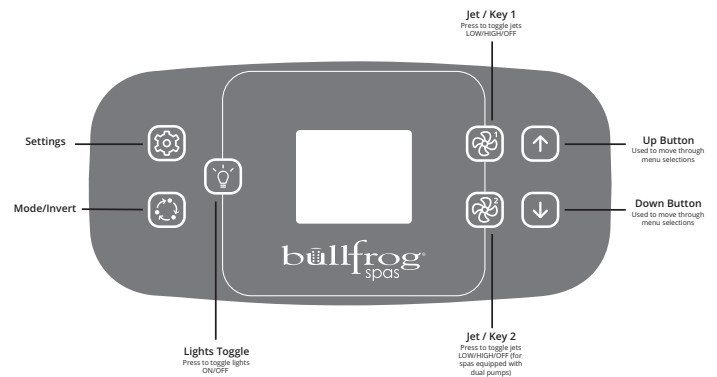

X Series Standard Control (without audio)

Home/Status Screen

The Home/Status screen on your X Series (X500) control shows basic statuses including: time, jet status, light status, current water temperature, spa operation mode, and heating/cooling status. In addition, many of the basic functions of operating your spa can be performed with one touch from the Home/Status screen. In addition, any necessary error or maintenance messages will appear at the bottom of the screen.

Start or Stop Accessories

To start or stop an accessory (jets, lights, etc.), press the associated button. Icons will become animated when their accessory is turned on, and inanimate when turned off. Icons on the screen will reflect the speed or state of the devices running on your spa. When an accessory has more than two states, press the button until it reaches the desired state.



Light Operation

Turn lights on and off using the button. Press once to turn the lights on. Press again to turn it off. Pressing the button repeatedly will cycle through light modes and colors (flashing, fading, solid color).

Screen Rotation/Mode Button





From the home status screen, you may press the button to rotate the screen 180 degrees for easier viewing from inside the spa.

Adjusting the Set Temperature

The water temperature is displayed near the bottom of the home status screen. Press the  and  buttons to set the desired temperature. The set point will appear in large type. Press again immediately to adjust the set point to your desired temperature. After 3 seconds without any change to the set temperature value, the Home/Status screen and with current water temperature in the upper right will reappear.

When the set value is lower than the current temperature “Cooling to xx.x” will appear at the bottom of the screen. When the set value is higher than the current temperature, “Heating to xx.x” will be indicated. Normally there is a short delay before the heating starts, during which “Heating suspended” is indicated under the value. When the water temperature reaches your set point a message of “Set point reached” will appear.

Spa Settings

The settings on the X Series (X500) control pad are navigated by the use of the  (Settings) button. One press gives you access to several menus where you can manage the specific settings of your spa. After pressing the Settings button you may navigate to each sub-menu by pressing the  and  buttons and then using the  (Light) button to select a sub-menu.

When using the Settings menu or sub-menus the screen will revert back to the Spa mode and Home/Status screen if no key is pressed for 60 seconds. Note that if an accessory is not present in your spa configuration, its menu will not appear. Refer to the following section to get details about the possible settings, accessories, and their detailed functionalities.

Water Care

The Water Care sub-menu will help you set up your ideal filtration and heating settings. Choose from Away, Standard - Beginner, Energy Saving, Super Energy Saving, and Weekender, depending on your needs and preferences.

Use the  (Light) button to select your setting. A check mark will appear within the selected icon to confirm your selected mode.

In the descriptions of each mode below “Economy mode” means that the set point will be reduced by 20°F* (11°C), which means that the heating system will not be engaged unless the temperature falls to 20°F (11°C) below the spa’s set temperature.

The filtration schedule shown on the screen will apply to the main filtration pump. If your spa uses a circulation pump configured to run 24 hours, the screen will show you the purge setting instead of filtration. The purges are pre-programmed for a fixed number of minutes, therefore the duration will be set to N/A on the screen, and only the start time can be modified.

Water Care Modes

NOTE: Your spa will come from the factory in “Super Energy Savings” mode. See operation mode options below and select the best mode for your anticipated usage.

1. Away

In Away mode the spa temperature set point will be reduced by 20°F (11°C) (see description of “Economy mode” above). Spa will remain in Economy mode at all times of the day and all days of the week.

Suggested use: Use when on vacation or not using the spa for longer than 2 weeks.

Economy time: Everyday of the week, 24 hours per day.

Filter cycle start time: 8:00 PM, duration 3 hours.

2. Standard – Beginner

In Standard mode the spa will heat to the set point and filter according to the spa’s standard configuration. Spa will heat to set point at all times and all days of the week. This is the default setting on new spas.

Suggested use: Use to maintain readiness for use everyday at all times of day.

Economy time: Will not use Economy mode.

Filter cycle start times: 8:00 AM, duration 1.5 hours and 8:00 PM, duration 1.5 hours.

3. Energy Savings

In Energy Savings mode the spa temperature set point will be reduced by 20°F (11°C) (see description of “Economy mode” above) during peak daytime hours. Spa will heat to normal set point during evening hours and on the weekend.

Suggested use: Use to save energy during weekday daytime hours and make ready for use at night and all day on weekends.

Economy time: Monday - Friday, 6:00 AM - 6:00 PM.

Filter cycle start time: 7:00 PM, duration 3 hours.

4. Super Energy Savings (factory default setting)

In Super Energy Savings mode the spa temperature set point will be reduced by 20°F (11°C) (see description of “Economy mode” above) during peak daytime hours. Spa will heat to normal set point during evening hours, every day of the week.

Suggested use: Use to save maximum energy and heat only during set filter cycles.

Economy time: Will not use Economy mode, only heats during filtration cycles.

Filter cycle start time: 8:00 AM, duration 1.5 hours and 8:00 PM, duration 1.5 hours.

5. Weekender

In Weekender mode the spa temperature set point will be reduced by 20°F (11°C) (see description of “Economy mode” above) from Monday to Friday. Spa will heat to set point at all times on the weekend (Saturday & Sunday).
Suggested use: Use when spa is used only on weekends and not on weekdays.





Economy time: Monday - Friday, 24 hours per day.



Filter cycle start time: 8:00 AM, duration 1.5 hours and 8:00 PM, duration 1.5 hours.

Default Settings: The Default Settings option will restore all Water Care modes and schedules to the spa’s default settings. You will be asked to confirm your choice.

NOTE: Spas NOT equipped with a dedicated filtration pump will turn on automatically, using jet pump 1 on low speed, to filter and/or heat. This is normal spa operation.

Modifying Water Care Schedules

To modify a Water Care mode schedule, press the  (Settings) button and then use the  (Light) button to enter the Water Care sub-menu. Highlight the water care mode (Away, Standard, Energy Savings, Super Energy Savings, Weekender) using the  (Light) button. To adjust the schedule of a particular mode next use the lighted key to the right of the screen, the  (Jets 1/Key 1) button, to open the selected Water Care schedule menu.

You can adjust schedules using the  (Light) button to cycle each menu item. Press the  (Light) button again to cycle to each sub-menu item and the and buttons to adjust times and schedules.

Once you have set your customized schedule, use the  (Settings) button to go back to the Home/Status screen.

Maintenance Reminders





The X Series (X500) keypad can be set up to remind you of several types of maintenance required on your spa, including rinsing the filter, cleaning the filter, changing spa

water, and 2-year professional maintenance checks. Each task has its own standard duration, based on normal use.

From the Settings page you can access the Maintenance menu, which gives you access to the following options:

- Maintenance reminders
- Standby mode







The maintenance reminders menu allows you to verify the time left before maintenance is required, as well as to reset the time once a task is completed.

Use the  and  buttons to choose the maintenance reminder that you wish to view. Select it by pressing the  (Light) button. To reset a reminder once maintenance has been performed select it by pressing the  (Light) button, then confirm it is “Done” by pressing the  (Jets 2/Key 2) button when prompted. Once you have confirmed the task reminder will be reset.









Selecting the Standby mode from the maintenance sub-menu allows you to service your spa. Pumps will stop for 30 minutes, and automatically restart after this time. Once Standby mode has been activated a screen will appear to show that pumps are stopped. The Home/Status page will return after the 30-minute standby maintenance period.

Use the  (Light) button to Cancel the Standby function before the 30-minute period and restart the spa.

Set Date and Time of Day

Setting the correct date and time is important for settings to function as expected. Upon restarting your spa adjust the time format (24 hr. or AM/PM), change the year, date, and time as needed. Within the Settings menu use the  (Light) button to select the Date & Time sub-menu. Use the  and  buttons to choose the setting that you wish to adjust, and select it by pressing the  (Light) button. Use the and buttons to change the parameters, and the  (Light) button to cycle between options. The  (Settings) button will take you back to the main Settings menu.



Adjust Keypad Settings

In this Settings sub-menu you can change the temperature unit, language, display orientation, and keypad security. Within the Settings menu use the and buttons and then the  (Light) button to select the Keypad Settings sub-menu. Use the  and  buttons to choose the setting that you wish to adjust, and select it by pressing the  (Light) button. Use the  and  buttons to change the parameters, and the  (Light) button to move between options. The  (Settings) button will take you back to the main Settings menu.

When you change the display orientation, the contextual options and arrow keys adjust to the chosen orientation.

The Mode and Menu keys remain unchanged, as well as the accessory keys in the main spa menu.

Screen Lock Settings







You can lock the keypad by selecting one of 3 security levels: Unlock, Partial lock, or Full lock. The Partial level locks the set point adjustment and many options in the settings menu. The Full level locks all keypad functions. Once you have selected your desired lock function press the  (Jets 1/Key 1) button. The display will prompt you to press and hold the  (Light) button for 5 seconds to activate the keypad lock function. To unlock the keypad (either Partial or Full), press and hold the  (Light) button for 5 seconds.



Electrical Configuration

IMPORTANT: Please do not make changes in this section unless you are a qualified electrician.

In this section you can change the low-level configuration, as well as modify the number of phases and the input current value.

*Please refer to the diagram on the spa control center box, located inside of the equipment compartment, for the default configuration of your specific spa model.

Press the  (Light) button to access the sub-menu, a warning will appear. Press the  (Light) button for 5 seconds when prompted to access the sub-menu options. Use the buttons to move to the selection you want to modify. Use the  (Light) button to select, and the  and  buttons to move through the selections. Press the  (Light) button again to confirm.

Please see the Techbook for your spa system for details on low-level settings. Once you have changed the number of phases in the menu you will be unable to use the  and  buttons to return to the Low-level configuration menu. Please go back and access the Configuration menu again.

NOTE: On initial connection the installer is prompted for electrical configurations. The Low-Level setting is selected by the installer. The Phase and Amperage is set automatically. Default settings should be confirmed by the installer to match the actual phase and amperage at the spa's installation location. On rare occasions, it may be necessary to adjust the Phase and Amperage setting to match the actual service available at the installation location using the instructions above.

*Depending on pack configuration, a code may be required to change the number, number of phases or input current. This code is "5555".

Restore/Audio configuration

When you select Restore, you will be asked to confirm your choice. Doing so will reset all settings to factory default. Following a restore you will be asked to choose your audio source. Use the buttons to choose between

in.stream, in.stream 2, in.tune and no/other audio. This should only be done at installation or when replacing a part.

About





This screen displays technical information about the control system (X500) software on your X Series spa and applicable revisions of the different components of your system.

Audio System Controls (Optional)

Press the  (Mode) button to access "in.stream 2" player controls.

If you are using a device with Bluetooth technology, it must be connected for functions to work. Use code 5555 to pair.

Note: Play/Pause functions apply only to Bluetooth and USB source. Change Track or station functions works with all sources except AUX.

Turning power On/Off: Press  to access Settings and then press  "Audio". Press  "Power" to turn the in.stream 2 on or off. Selecting the source: Press  to access Settings and then press  "Audio". Press "Source" to toggle between available sources.

Play/Pause audio: Press the Play/Pause button to start or pause the audio.

Adjusting the volume: Press the Volume Up or the Volume Down key to increase or decrease the volume.

Changing tracks: Use the Last Track and Next Track keys to change tracks. Note that in FM mode these functions can be used to change stations.

Disconnect: This option can be found under the Audio section in the Settings menu.

Fader, Balance and Subwoofer: Fader, Balance and Subwoofer settings can be edited under the Audio section in the Settings menu if your in.stream 2 supports it.

The first time you use your Bluetooth device with an X Series Audio system you must first "pair" your device to the spa audio system according to the standard pairing functionality of your specific device. Each device must be paired separately. Use code 5555 to pair.

For proper function, place your Bluetooth device within 20 feet (6 meters) of your spa. The device should have "line of sight" to the spa control panel / equipment door area.



NOTE: Certain house construction materials and other obstructions can impair Bluetooth connectivity. You may need to experiment with where to place your device for best results.

X Series Touch screen control (Optional)



Start Up

Fill the spa to its correct operating level. Be sure to open all valves in the JetPaks and all other jets in the spa before filling to allow as much air as possible to escape from the system during the filling process. For details see “Filling your spa” section. After turning the power on at the main power panel, the control panel display will go through an initializing sequence. This sequence displays information regarding the configuration of the hot tub control. After a few seconds, your control will display a standard status screen with time, jet and light status, temperature status, operation mode, etc.

Power

Tap screen to wake up the control. Touch and drag the logo icon  to the reverse logo icon  to unlock and access controls. After 30 minutes without activity the touch control will shut off.

Priming the Pumps

Pumps must be primed directly after filling to ensure correct operation of your spa. After initial startup, verify that the home status screen appears on the panel. To prime the pumps, press the  “Jets 1” button once to prime in low-speed. After the pump turns on and water is visibly flowing from the jets wait a few seconds and then press  “Jets 1” again to initiate high-speed operation of Pump 1. The pump has primed when water is flowing from the jets.

If your spa is equipped with a second jet pump repeat the priming process for Pump 2 by pressing the  “Jets 2” button once to turn on low speed and then a second time to turn Pump 2 on high.

To prime pumps 1 and 2 follow the instructions above. Press the  “Jets 3” button to prime the third jet pump. All pumps will have primed when water is observed flowing from the jets associated with each pump.

IMPORTANT: Pumps should not be allowed to run without priming (no water flowing out of the jets) for more than two minutes. Doing so may cause damage to the pump(s).

NOTE: Sometimes momentarily turning the pump off and on will help it to prime. Do not do this more than 5 times. If the pump(s)

IMPORTANT: Your Bullfrog Spa is equipped with one of three types of main control systems that correspond to the spa series. Locate the control system on your spa by matching it with the photo provided under each control panel section and follow the specific instructions in that section for operation of your spa.

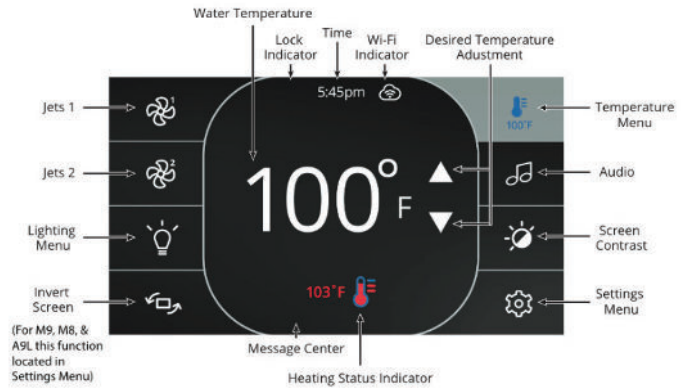

X Series Touch Control

Home/Status Screen



The Home/Status screen on your control shows basic statuses including: time, jet status, light status, screen orientation, current water temperature, heating/cooling status, spa operation mode, audio status (optional), day/night status, and settings. Most basic functions of operating your spa can be performed with one touch from the Home/Status screen. In addition, any necessary error or maintenance messages will appear at the bottom of the screen.

Start or Stop Accessories

To start or stop an accessory (jets, lights, etc.), press the associated button. Icons will become animated when their accessory is turned on, and inanimate when turned off. Icons on the screen will reflect the speed or state of the devices running on your spa. When an accessory has more than two states, press the button once, and then again, until it reaches the desired state.

To turn on all available spa pumps in one touch press the  “Logo” button, located to the side of the main control screen. Press the button again to turn off all available pumps.



Light Operation

Use the  button to access the lights menu. Use the  button to turn on interior lights. Use the  button to turn on exterior lights. Use the associated menu options to control interior light modes (flashing, fading, solid color) and/or colors.

Invert Screen Button

From the home status screen you may press the  button to rotate the screen 180 degrees for easier viewing from inside the spa.

Adjusting the Set Temperature

Within one to two minutes after spa start up and initialization, the water temperature will be displayed in the center of the home status screen. Press the  and  buttons to set the desired temperature. The set point will appear in blue. After three seconds without any change to the set temperature value, the current water temperature will reappear in white.

When the set value is lower than the current temperature “Cooling to xx.x” will appear at the bottom of the screen.

When the set value is higher than the current temperature, “Heating to xx.x” will be indicated. Normally there may be a short delay before the heating starts, during which “Heating suspended” is indicated under the value.

Spa Settings

The settings on the control pad are navigated by the use of the  (Settings) button. One press gives you access to several menus where you can manage the specific settings of your spa. After pressing the Settings button, you may access a sub-menu by pressing the associated icon.

Note that if an accessory is not present in your spa configuration, its menu will not appear. Refer to the following section to get details about the possible settings, accessories, and their detailed functionalities.

Water Care

The Water Care sub-menu will help you set up your ideal filtration and heating settings. Choose between Away from Home, Standard/Beginner, Energy Savings, Super Energy and Weekender, depending on your needs. Touch the Water Care mode name to choose your setting. A confirmation message will appear to prevent inadvertent modification of spa water care settings. Touch the check icon to confirm your choice or touch the X icon to decline.

In Economy mode, the set point will be reduced by 20°F*, which means that the heating system will not be engaged unless the temperature falls to 20°F below the spa’s set temperature.

The filtration schedule shown on the screen will apply to the main filtration pump.

Water Care Operation Modes

NOTE: Your spa will come from the factory in “Super Energy Savings” mode. See operation mode options below and select the best mode for your anticipated usage.

Away

In Away mode the spa temperature set point will be reduced by 20°F (7°C) (see description of “Economy mode” above). Spa will remain in Economy mode at all times of the day and all days of the week.

Suggested use: Use when on vacation or not using the spa for longer than two weeks.

Economy time: Every day of the week, 24 hours per day.

Filter cycle start time: 8:00 PM, duration three hours.

Standard – Beginner

In Standard mode the spa will heat to the set point and filter according to the spa’s standard configuration. Spa will heat to set point at all times and all days of the week. This is the default setting on new spas.

Suggested use: Use to maintain readiness for use every day at all times of day.

Economy time: Will not use Economy mode.

Filter cycle start times: 8:00 AM, duration 1.5 hours and 8:00 PM, duration 1.5 hours.

Energy Savings

In Energy Savings mode the spa temperature set point will be reduced by 20°F (7°C) (see description of “Economy mode” above) during peak daytime hours. Spa will heat to normal set point during evening hours and on the weekend.

Suggested use: Use to save energy during weekday daytime hours and make ready for use at night and all day on weekends.

Economy time: Monday - Friday, 6:00 AM - 6:00 PM.

Filter cycle start time: 7:00 PM, duration three hours.

Super Energy Savings (factory default setting)

In Super Energy Savings mode the spa temperature set point will be reduced by 20°F (7°C) (see description of “Economy mode” above) during peak daytime hours.

Spa will heat to normal set point during evening hours, every day of the week.

Suggested use: Use to save maximum energy and heat only during set filter cycles.

Economy time: Will not use Economy mode, only heats during filtration cycles.

Filter cycle start time: 8:00 AM, duration 1.5 hours and 8:00 PM, duration 1.5 hours.

Weekender

In Weekender mode the spa temperature set point will be reduced by 20°F (7°C) (see description of “Economy mode” above) from Monday to Friday. Spa will heat to set point at all times on the weekend (Saturday & Sunday).

Suggested use: Use when spa is used only on weekends and not on weekdays.

Economy time: Monday - Friday, 24 hours per day.

Filter cycle start time: 8:00 AM, duration 1.5 hours and 8:00 PM, duration 1.5 hours.

Default Settings: The Default Settings option will restore all Water Care modes and schedules to the spa’s default settings. You will be asked to confirm your choice.

Modifying Water Care Schedules

To modify a Water Care category, touch the pen icon at the right of the desired Water Care option to open the sub-menu.

Touch the Economy tab to change the economy setting and Filter cycle tab for the filtration settings (or schedules). You can add economy or filtration schedules by touching the title labeled “Add filter cycle” or “Add economy cycle”. To delete a schedule, touch the garbage can icon at the right of the desired function title. Confirm your action when prompted.

You can modify the programmed schedules by selecting one and adjusting the schedule. You have several possibilities for the schedule (Mon-Fri, weekend, every day, or single days). The schedules will be repeated each week. The time and duration are set in 30-minute increments. When changes are done, press “confirm”. If you don’t want to keep any changes, press “cancel” or use the calendar icon to go back. Ensure that you have selected the desired Water Care mode in the main Water Care menu.

Reminders

The keypad can be set up to remind you of several types of maintenance required on your spa, including rinsing the filter, cleaning the filter, changing spa water, and two-year professional maintenance checks. Each task has its own standard duration, based on normal use, or you may adjust to fit your specific expected usage.

Access the Reminders sub-menu by pressing the  Reminders icon in the Settings menu.

Maintenance reminders allow you to verify the time left before maintenance is required, as well as to reset the time once a task is completed.

To reset a task, select it by pressing the title of the specific reminder, then confirm when prompted. Once you have confirmed, the task timer will be reset. You can also use the option “Reset Reminders” to reset all the reminders.

Set Date and Time of Day

Setting the correct date and time is important for settings to function as expected. Upon restarting your spa adjust the time format (24 hr. or AM/PM), change the year, date, and time as needed. Within the Settings menu select “Date & Time” to access these submenus. Select “Set Date” to adjust the year, month and day. Swipe up and down the column you want to change and select the desired value. When you are done, touch the  Settings icon to save.



Select “Set Time” to change the hour, minute and time format. Swipe up and down the column you want to change and select the desired value. When done, touch the  Settings icon to save.

Keypad Settings

In the Keypad submenu you can change the temperature unit settings or the language setting. Change temperature units by touching the “Temperature Units” title and then the desired unit of measurement.

Change the language setting by touching the “Language” title and then selecting the desired language.

Standby/Lock

Standby mode allows you to service your spa. Pumps can be stopped for 30 minutes in this mode, and will automatically restart after. Select Standby mode by pressing the  pause/standby icon. The home/status screen and normal spa function will resume after the 30-minute standby period. The Lock option allows the user to partially or completely lock the keypad. Selecting the  “Lock” option will lock all functions on the control while the “Partial Lock” option will allow jets, audio, and lights to remain functional.

To lock the keypad, select “Lock Settings” then select “Lock” or “Partial Lock” according to the functions you wish to lock. When asked, select a four-digit code. The same code will be needed to unlock the keypad. To lock the keypad again, you will be prompted to select another four-digit code.

The keypad can be unlocked with a universal unlock code (3732) or by a reset of the keypad. When Full Lock is selected, all functions are locked. In Partial Lock, you may activate accessories, but spa settings may not be changed.

Air Valve Controls

X Series premium seats have an air valve control. The air for these seats can be turned off or on by turning the air valve control associated with that specific seat, and each spa model will have one to two of these controls. They are typically located on either side of the control panel. Air valves control the air from jets in a specific seat, typically the premium seats for your spa model. Air can be turned on or off depending on the user’s desired therapy.

Diverter Valve

The diverter valve is used to direct water flow from the pump to a specific seat that the user will be sitting in. Water flow can be dispersed to all jets that are powered by that pump or it can be diverted to a specific seat. This diverter valve regulates the flow of the water so that the user can dial in the correct therapy the desire

To use the diverter valve:

Step 1: Turn the valve in the direction you’d like the water to flow. For instance, if you’d like water to divert to the right seat, turn the valve to the right, etc.

Step 2: To evenly distribute water flow to all seats, set the valve to the middle and receive equal jet power to each seat.

WATER CARE & CHEMISTRY

Chemicals

Properly maintaining your spa water is very important to ensure enjoyment in using your spa and to maximize spa shell and equipment life. Properly maintaining your spa water chemistry will require regular attention to prevent poor water quality, potential unhealthy conditions, and possible damage to your spa.

For all water care related questions please refer all water care-related questions and concerns to your local Authorized Bullfrog Spas Dealer. Your Authorized Bullfrog Spa dealer can recommend the correct products and procedures for safely sanitizing and maintaining your spa according to local water chemistry, regulations, and your specific circumstances.

Suggested Water Care Method: FROG® @ease® (USA Only)

Beginning in 2019 all 2-filter Bullfrog Spas come equipped with an @ease-ready holder system installed in the filtration compartment. This holder accepts FROG @ease system cartridges (mineral & SmartChlor® chlorine) designed specifically for Bullfrog Spas. The holder is backward compatible for all 2013-later, 2-filter Bullfrog Spas. The @ease system holder and system cartridge kits may be obtained through your Authorized Bullfrog Spas Dealer.



FROG® @ease® is a hot tub sanitizing system* custom designed for Bullfrog Spas® that takes the guess work out of water care so you always feel at ease while enjoying your hot tub.

FROG @ease Mineral Cartridge DIRECTIONS FOR USE: For use in hot tubs up to 600 gallons. Use with the FROG @ease SmartChlor Cartridge in the FROG @ease Sanitizing System for Bullfrog Spas. Ensure all hot tub equipment is working properly. Operate the pump and filter as recommended by your hot tub manufacturer. Clean filter following manufacturer's directions. May be used with a previously filled hot tub unless it was sanitized with bromine or biguanides. Then drain and fill the hot tub with fresh water before using this product. Start-up: Adjust pH to between 7.2-7.8 and Total Alkalinity between 80 and 120. Establish a free chlorine residual of 0.5 to 1.0 ppm with FROG Jump Start start-up shock or an EPA approved hot tub shock following the directions on that product. Setting the FROG @ease Mineral Cartridge: Turn the dial on the bottom of the cartridge to setting number #4. Using the System: Remove filter snap cap and weir door / filter plate. Remove cartridge holder from hot tub by pulling up on the handle. Snap cartridge into one opening of the holder. With the FROG @ease logo facing the holder, put the dial end of cartridge into the holder first by connecting the tab on the holder with the indent in the cartridge. Then push the top part of the cartridge in until it snaps into place. For best results insert the FROG @ease SmartChlor Cartridge into the other opening. When cartridge is snapped in, replace holder between the filter cartridges under weir door/ filter plate pushing down until it stays in place. Then replace the filter snap cap.

For complete instructions read the entire manual.

Step 1: Prepare the Hot Tub

1.



Fill hot tub with fresh water. If using source water that is high in iron or other metals, see your dealer before filling the hot tub. It may require the use of a metal control product.

If previously using bromine and switching to FROG @ease System, you must drain and refill your hot tub before using this product.

If previously using dichlor you may convert to FROG @ease System without having to drain the hot tub.

2.

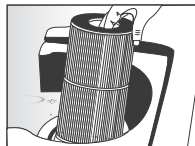

Clean or replace filter cartridges when dirty (Follow manufacturer's instructions).

IMPORTANT: Always follow printed instructions on the balancing chemical packages. Add balancing chemicals in small increments one at a time with the jets on and wait 6 hours before testing again and adding any additional balancing chemicals.

Water Balance Guidelines	
pH:	7.2 – 7.8
Total Alkalinity:	80 - 120 ppm
Calcium Hardness:	150 - 250 ppm
Total Dissolved Solids:	<1500

a. Take a water sample from the hot tub and dip a FROG @ease Test Strip into it.



b. Look at the **Total Alkalinity** reading first. Adjustments should be made to bring the Total Alkalinity in the **range of 80 – 120 ppm** prior to making any adjustments to pH even if it throws pH off further.

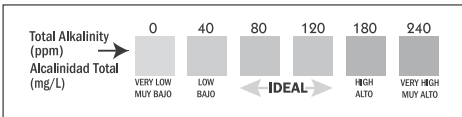

c. After Total Alkalinity is in range, **test for pH**. It should be **between 7.2 and 7.8**. If higher or lower, add a pH adjuster.

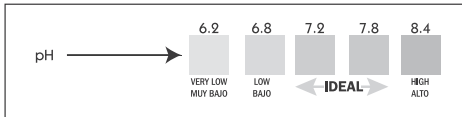

d. Lastly **test for Calcium Hardness**. It should be **between 150 and 250 ppm**. If higher, partially drain the hot tub (about 6 inches) and fill with water low in calcium. If lower, add Calcium Increaser.

If balancing takes longer than 2 days shock the water and maintain a chlorine level while continuing balancing.

4.  **Very Important!** After balancing and before using cartridges, establish an initial residual of 0.5 - 1.0 ppm free chlorine with FROG® Jump Start® start-up shock, included in this package, that quickly dissolves with an effervescent fizzing action – one packet per 600 gallons.

5. Heat water to the manufacturer’s recommended temperature.

Active Ingredient:	KEEP OUT OF REACH OF CHILDREN
Silver Chloride0.5%	CAUTION
Other Ingredients:99.5%	It is a violation of Federal Law to use this product
Total:100.0%	in a manner inconsistent with its labeling.

Step 2: Set the Cartridges

The FROG @ease System has two replaceable cartridges.

Blue = FROG @ease Mineral Cartridge Silver = FROG @ease SmartChlor Cartridge

The combination provides the Fresh Mineral Water benefits of cleaner, clearer and softer water that's easier to take care of.

1. Remove the FROG @ease SmartChlor Cartridge from its bag before proceeding.

2. Set the FROG @ease Mineral Cartridge to #4 using the dial on the bottom of the cartridge. No further adjustments are necessary for the life of the cartridge.



Bullfrog Spa Models	Setting #
A5L, R5L	1
A6, A6L, R6, R6L, STIL5, X7, X7L	2
M7, A7, A7L, A7D, R8L, R7, R7L, STIL7, X8, X8L	3
M9, M8, A9L, A8, A8L, R8	4

3. Set the FROG @ease SmartChlor Cartridge to the setting that matches your hot tub model number. If needed, you may increase or decrease the dial setting.

Once set, the FROG @ease SmartChlor Cartridge will maintain a low 0.5 to 1.0 ppm chlorine level as long as the pH stays within 7.2 and 7.8 so typically there is little need to adjust the cartridge setting.

Step 3: Put The System To Work

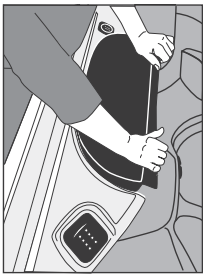

1. Remove filter snap cap.



2. Hold weir door/filter plate out into the hot tub slightly or remove from hot tub. If cartridge holder is already installed between the filter cartridges, remove by pulling up on the handle.

3. Snap the FROG @ease Mineral Cartridge into one opening of the cartridge holder. With the @ease logo facing the holder, put the dial end of the cartridge into the holder first by connecting the tab on the holder with the indent in the cartridge.

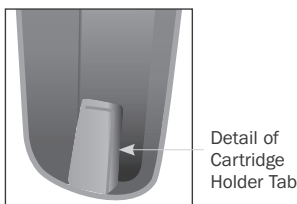
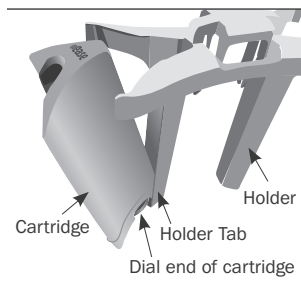

4. Then push the top part of the cartridge in until it snaps into place

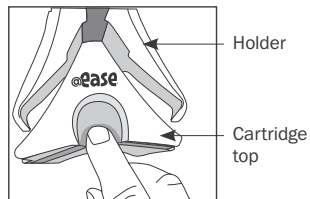

5. Follow the same procedure for the FROG @ease SmartChlor Cartridge into the other opening.

6. With the silver FROG @ease SmartChlor Cartridge facing the inside of the hot tub, insert cartridge holder between the filter cartridges under the weir door/filter plate pushing down until it stays in place.

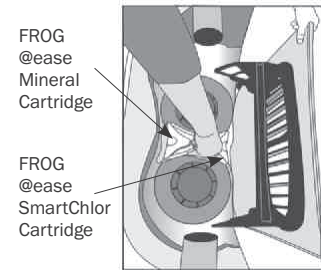

7. Replace filter snap cap.



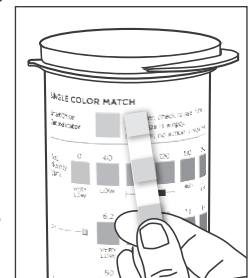

Replacing Cartridges

Replace FROG @ease Mineral Cartridge every four months. Discard it in the trash even though you will hear the spent media left inside. Don't attempt to reuse: the minerals are spent after 4 months. Replace FROG @ease SmartChlor Cartridge when empty based on the FROG @ease Test Strip showing a lighter color than the out indicator on the bottle. The life of the cartridge varies depending on hot tub size and number of users. FROG @ease SmartChlor Cartridge will last about 3-4 weeks for an average 400 gallon hot tub. Drain water from cartridge to ensure it is empty. Discard in trash or offer for recycling if available.

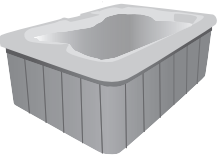

Step 4: Routine Hot Tub Care

1.  Drain and refill hot tub as directed by your hot tub manufacturer or every four months when FROG minerals need to be replaced.

2.  Run filtration system as recommended by your hot tub manufacturer to maintain proper water flow through the system.

3.  Regularly test water with FROG @ease Test Strips and follow directions in Step 1 for maintaining pH, Total Alkalinity and Calcium Hardness.

NOTE: pH is affected by bather load, chemicals used, evaporation and the make-up of your source water so maintaining water balance regularly is important.

4. FROG @ease SmartChlor Cartridge will maintain 0.5-1.0 ppm free chlorine level as long as the water is balanced.
NOTE: Free Chlorine levels are reduced up to 75%* when using FROG @ease Minerals.

NOTE: Why FROG @ease Test Strips? The FROG @ease SmartChlor Cartridge forms a chlorine reserve that will be inaccurately measured as total chlorine on other test strips. Unlike conventional chlorine, the SmartChlor reserve readily shifts to free chlorine as needed, maintaining spa health with a low level of chlorine.

5.  Shock the hot tub with a non-chlorine shock when you replace the FROG @ease SmartChlor Cartridge or once a month.

6.  Replace your FROG @ease SmartChlor Cartridge and complete FROG @ease System that comes with a FROG @ease Mineral Cartridge as directed under “Step 3: Put the System to Work”.

Troubleshooting

Cloudy Water or Low-Chlorine Levels

- Check water balance. pH and Total Alkalinity need to be in the proper ranges for the FROG @ease System to work correctly.
- Check FROG @ease SmartChlor Cartridge and replace if empty—see instructions under “Put the System to Work”.
- If FROG @ease SmartChlor Cartridge is not empty, turn dial setting up 1 number and monitor chlorine levels for a few days while maintaining water balance. If needed turn dial up again.
- Check your calendar. The entire FROG @ease System including a FROG @ease Mineral Cartridge needs to be replaced every four months. Without the minerals, SmartChlor will not be enough to sanitize the hot tub.

FROG @ease SmartChlor Cartridge Life

- If hot tub is larger than 400 gallons with significant bather load, you may require a higher dial setting which will shorten the cartridge life.

- If you think the cartridge setting is too high, you can turn the dial setting down 1 number and monitor chlorine levels for a few days while maintaining water balance. If needed, turn dial down again.

High Chlorine Levels



- This is highly unlikely with the FROG @ease System because SmartChlor is self-regulating. However, if you use standard test strips, it may appear that total chlorine is higher than the free chlorine.
- No worries—the strip is measuring the SmartChlor reserve, which will shift to free chlorine as needed. Please always use the FROG @ease Test Strips that were included with your System.

Learn more at frogproducts.com or call 800.222.0169
Register your FROG @ease Sanitizing System at frogproducts.com



Manufactured by: King Technology
530 11th Ave S, Hopkins, MN 55343 U.S.A.
952-933-6118 • Customer Service 800-222-0169
frogproducts.com

+ FROG @ease System consists of the FROG minerals silver chloride and carbonate used with 0.5 ppm of FROG @ease SmartChlor Cartridge. The FROG @ease Mineral Cartridge (EPA Reg. No. 53735-11) must be used in conjunction with the FROG @ease SmartChlor Cartridge (EPA Reg. No. 53735-14).
* Compared to the minimum ANSI recommended chlorine level of 2.0 ppm for a hot tub.

Made in U.S.A. Patents: kingtechnology.com/IP
EPA Est. No.: 64114-MN-1 E081418553101843N 20-48-0108

Additional Water Care Methods (alternative or outside USA)

In areas where the FROG @ease system is not available (outside the USA) consult your local Authorized Bullfrog Spas dealership for specific options for maintaining water quality. Your Authorized Bullfrog Spa dealer who can recommend the correct products and procedures for safely sanitizing and maintaining your spa according to local water chemistry, regulations, and your specific circumstances.

CAUTION:

- Always follow chemical manufacturers' instructions and never mix chemicals.
- Use an accurate test kit to perform all chemical tests.
- Add chemicals directly to the spa, evenly spreading the chemicals over the surface of the water with the jets operating, or use an appropriate feeding or metering device and check chemical levels often.
- Run the filter pump on high speed, with the cover removed, for at least 30 minutes after applying any chemicals to mix adequately and avoid potential damage to equipment, accessories, or surfaces.
- Names of spa chemicals will vary from one manufacturer to another. Please contact your authorized Bullfrog Spas dealer if you have any questions.

Changing Spa Water

As you use your spa, soap and detergent residues from your skin and bathing suits, along with other substances from maintaining the spa's water chemistry will accumulate in the spa water and make maintaining the water more difficult. Rinsing your bathing suits and showering without soap prior to entering your spa will increase the life of your spa water. Depending upon usage, the spa water will need to be changed every 1-4 months or when the water chemical levels become difficult to manage. When changing spa water, remove all JetPaks. Clean the shell and jet pod areas with a spa surface cleaner. See Spa Shell Care. Clean the other areas of the spa, including JetPaks, with a spa surface cleaner as necessary.

IMPORTANT: Drain your spa to an area that can handle a large quantity of water. If draining water onto vegetation, make sure that the sanitizer level (chlorine or bromine) of the water is less than 0.5 PPM.

WARNING: Avoid drainage that can lead into basement window wells or any other area where damage could occur.

Regular Spa Water Care Sanitizer and pH Levels

It is important to test and adjust the sanitizer and pH level of your spa on a frequent basis. If the spa is used 0-3 times weekly, we recommend that you test the water a minimum of 2-3 times a week. For each additional use, test the water one additional time. Test kits and supplies are available from your authorized Bullfrog dealer.

pH Control: Proper pH balance is extremely important in controlling bacteria, providing water that is comfortable to the user, and preventing damage to the spa and equipment. The pH scale ranges from 0-14. Levels of pH less than 7.0 are acidic while pH levels greater than 7.0 are basic. The proper pH range for a spa is 7.4-7.6.

High pH levels (greater than 7.6): Can cause scale build-up on the spa and its equipment, cloudy water, a prematurely dirty filter, and less effective chlorine sanitation. To correct high pH levels, add a pH decreaser.

NOTE: Never use Muriatic or Hydrochloric acid to adjust pH as it can damage the spa shell and surroundings.

Low pH levels (less than 7.4): Can cause discomfort to the spa users and corrosion to the spa equipment. To increase pH levels, add a pH increaser.

Always test, and adjust the pH level before you test and adjust the sanitizer level.

Sanitation: Spa water sanitizers kill bacteria and keep the water clean. Effective and safe sanitizers recommended by Bullfrog Spas are granular chlorine (Dichlor) or granular bromine. Chlorine and bromine are the only two spa sanitizers approved for use in spas by the EPA.

WARNING: Trichlor chlorine tablets should never be used in a portable spa. Dissolve rate, potency and the extreme low pH of this chemical can cause severe damage to the spa surface and components. Use of trichlor chlorine tablets will void the Bullfrog Warranty.

Bromine and Dichlor tablets are also not recommended as an acceptable sanitizer in Bullfrog Spas unless an appropriate feeding or metering device is used and the water is frequently tested and monitored as excessive bromine or chlorine in the spa can cause surface damage and component failure.

SPA MAINTENANCE

WARNING: An empty spa (spa without water in it) must not be left exposed to sunlight as shell damage may occur. Once the spa is unwrapped, fill spa with water immediately or shade the spa with cover or wrapping to prevent direct exposure to sunlight.

Spa maintenance:

With each sanitizer test, use either granular Chlorine or Bromine to maintain the following levels:

- Chlorine Level: 3.0 to 5.0 PPM (parts per million)
- Bromine Level: 3.0 to 6.0 PPM (parts per million)

Super Sanitation or Spa Shock

Normal sanitation does not eliminate non-filterable wastes, such as perspiration, oils, hair sprays, etc., which may build up in the water. These substances make the water unattractive, and can interfere with sanitizer effectiveness. Super sanitation is achieved by “shocking” the spa water with a non-chlorine shock (Potassium Peroxymonosulfate), granular chlorine (Dichlor), or granular Bromine (Bromine concentrate).

Super Sanitize the water once a week by adding one of the following:

- Granular chlorine 2 teaspoons (10ml) of per 200 gallons (909.2l) of water
- Granular bromine 4 teaspoons (20ml) of per 200 gallons (909.2l) of water
- Non-chlorine Shock 5 teaspoons (25ml) of per 200 gallons (909.2l) of water

NOTE: Super sanitation may be required more than once per week for heavy usage. With ozone, it may not be necessary to shock the water on a weekly basis, contact your authorized Bullfrog Spas dealer for more information.

Total Alkalinity (TA): Total alkalinity (TA) is the quantitative measurement of alkaline components (carbonates and bicarbonates) present in water to act as a buffer against rapid pH changes. Proper total alkalinity levels are important to ensure optimal chemical balance in spas. Low TA can cause pH to be unstable. To correct low TA, add a Total Alkalinity Increaser. High TA can cause the water to be scale forming, cloudy and corrosive to the spa and its components, as well as other pH related problems. If the spa water has high TA, contact your authorized Bullfrog Spas dealer.

Calcium Hardness (CH): Calcium hardness (CH) is the measure of dissolved calcium in the water. Low CH (soft water) can stain the spa surface as well as cause corrosion to the spa and its equipment. To correct low CH, add a calcium hardness Increaser. High CH (hard water) can

cause cloudy water as well as rough scale build-up on the spa surface and equipment. If the spa water has high CH, contact your authorized Bullfrog Spas dealer.

Stain and Scale Control: Stain and scale problems are common in hot water environments. To help prevent and control staining and scaling, use a stain and scale inhibitor per the manufacturer’s instructions. Add stain and scale inhibitor 3-4 days after super sanitation.

Foam Control: Spa water that contains body oils, lotions and soap residue combined with high water temperatures can cause excessive foaming on the water’s surface. For a temporary fix add a foam remover as per the manufacturer’s instructions. The best way to control foam is to super chlorinate the water; this will destroy the soap agents that normal levels of sanitizer will not. Add 2 tablespoons (20 ml) per 100 gallons (454.6 liters).

Cloudy Water Prevention and Control: There are two basic reasons that spa water becomes cloudy. First, non-filterable liquid waste (e.g. perspiration) has contaminated the water. To remove these substances, Super Sanitize the water. Second, non-filterable micro-particulate waste (e.g. dust) has contaminated the water. To remove these substances use a Water Clarifier as per the manufacturer’s instructions.

Water Chemistry Troubleshooting

Prior to each spa use, check the water. If the water appears cloudy, off color, has significant surface foam, or smells of excessive chlorine/bromine, the water needs to be treated or drained. Using the spa in these conditions could result in irritations.

For assistance in handling spa water chemistry, contact your authorized Bullfrog Spas dealer or another service center capable of performing a computerized water analysis.

Your Bullfrog Spas spa may be equipped with the EOS enhanced ozone purification system. Long term maintenance of this system requires the replacement of the O3 Filter Cartridge approximately every 24 months. Contact your authorized Bullfrog Spas dealer for replacement cartridges and more information.

Freeze Protection

NOTE: Your spa is equipped with a freeze protection mode. When potentially freezing outside temperatures are detected your control system will turn on to check the water temperature. If heating is necessary to protect from freeze conditions your spa may turn on and heat to a safe temperature. A notification will display on the main control screen indicating this mode is engaged.

Ozone Purifier (Optional)

The EOS premium ozone system operates automatically when installed. Spas with EOS installed may experience a reduced need for chemical sanitizer, allowing for the maintenance of sanitizer levels closer to the suggested minimum recommended level of 3 PPM. Always maintain an absolute minimum of 2 PPM. The EOS system may also potentially reduce the frequency of super sanitization or spa shock application to a bi-weekly basis or less depending on usage patterns.

The Bullfrog EOS requires no special maintenance during normal usage. Long-term maintenance does require the replacement of the Carbon filter cartridge approximately every 24 months. Contact your authorized Bullfrog Spas dealer for more information.

Your Bullfrog Spas spa may be equipped with an optional WellSpring High Output ozone purification system. This system may also reduce your sanitizer usage. Contact your authorized Bullfrog Spas dealer for information on periodic maintenance or replacement of ozone system parts.

Changing Spa Water

As you use your spa, soap and detergent residues from your skin and bathing suits, along with other substances from maintaining the spa's water chemistry will accumulate in the spa water and make maintaining the water more difficult. Rinsing your bathing suits and showering without soap prior to entering your spa will increase the life of your spa water. Depending upon usage, the spa water will need to be changed every 1-4 months or when the water chemical levels become difficult to manage. When changing spa water, remove all JetPaks. Clean the shell and jet pod areas with a spa surface cleaner. See Spa Shell Care. Clean the other areas of the spa, including JetPaks, with a spa surface cleaner as necessary.

IMPORTANT: Drain your spa to an area that can handle a large quantity of water. If draining water onto vegetation, make sure that the sanitizer level (chlorine or bromine) of the water is less than 0.5 PPM.

WARNING: Avoid drainage that can lead into basement window wells or any other area where damage could occur.

To Drain Your Spa:

Step 1: Turn-off main electrical breaker to spa.

Step 2: Locate drain below equipment compartment door.

Step 3: Pull the drain out with a slight clockwise turn. Use pliers if needed.

NOTE: Drain is fully extended at approximately 2 inches (5 centimeters).

Step 4: Remove drain cap.

NOTE: The drain spout will not drain when fully extended.

Step 5: Attach a standard garden hose. Push the drain spout in halfway to actuate the drain.

NOTE: The Spa will drain about 5 gallons (20 liters) per minute. Ensure that the drainage is in an area safely away from window wells or basement entries.

Step 6: Once the spa is fully drained, pull the drain spout out all the way, remove hose, replace the drain cap and push drain in all the way.

To Refill Your Spa:

WARNING: When refilling the spa, always super sanitize the new water by adhering to the instructions in the Water Chemistry section.

Fill the spa to its correct operating level. Be sure to open all valves and jets in the spa before filling to allow as much air as possible to escape from the system during the filling process. For details see "Filling your spa" section. After turning the power on at the main power panel, the control panel display will go through an initializing sequence. This sequence displays information regarding the configuration of the hot tub control. After a few seconds, your control will display the Home/Status screen which shows time, jet and light status, temperature status, operation mode, etc.

Filter Maintenance (X Series)

It is recommended that pleated cylindrical filter cartridge(s) used in A Series, R Series, X Series, and STIL spas be cleaned every 3-6 weeks or as needed. Spas equipped with the optional circulation pump system may require increased cleaning intervals based on use and local water conditions.

Replace the filter cartridge(s)

After multiple cleanings, worn filter cartridges will need to be replaced. To maintain warranty protection, use only genuine Bullfrog Spas filter cartridge replacements. To clean or replace your filter cartridge(s), complete the following:

CAUTION: Never operate spa with the filter(s) removed.

Step 1: Turn off main power to the spa.

Step 2: Remove filter cap and filter plate.



Step 3: Remove the pleated cartridge(s) by turning the filter core cap(s) counter clockwise then sliding the cartridge(s) upward from the filter core.



Step 4: Using a garden hose with a nozzle or other high-pressure device, clean cartridge(s). Work first from the inside, top to bottom on each pleat then from the outside, top to bottom on each pleat.

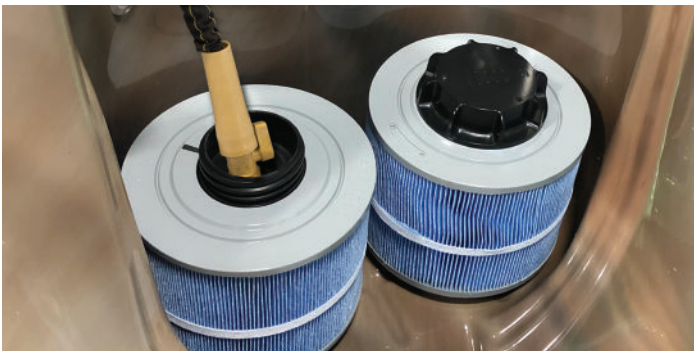

- To remove collected lotions or body oils, soak cartridge(s) in warm water with a filter cleaner or detergent.
- To remove calcium deposits, soak cartridge(s) in a plastic container using a 1:10 ratio of muriatic acid to water solution. Calcium deposits indicate a high spa pH, which should be corrected.

NOTE: Filter(s) must be cleaned with a filter cleaner/degreaser before attempting to remove calcium and mineral deposits with any acidic based product

Step 5: Reinstall cartridges(s) by aligning the cartridge slot with the filter core fin; reinstall the filter core cap(s), filter plate, and filter cap.

Step 6: Restore main power to the spa.

IMPORTANT: Using a brush to clean a filter cartridge could cause damage to the filter media.

Spa Surface Care

IMPORTANT: Your spa cover is an essential part of the spa system in order to protect spa surfaces, ensure safety, and to provide the highest possible efficiency. Ensure the cover is in place at all times except during spa use.

General Cleaning

For normal cleaning, use a mild dish-washing soap, window cleaner, or other products recommended by your local authorized Bullfrog Spas Dealer. For stubborn stains, use a mild acrylic cleaner or a mild detergent. To apply these cleaners, use a soft, damp cloth or sponge. Rinse well and dry with a clean cloth. To clean hard water stains, remove light scratches and protect your spa shell, contact your authorized Bullfrog Spas Dealer.

Cleaning a Surface Buildup Line

With normal use of the spa, oils, lotions, and hair products can build up on the surface of the water in small amounts. This could leave a line around the perimeter. This buildup can be easily removed using a spa surface cleaner or its equivalent. Avoid using cleaning agents that leave soap residue in the water.

WARNING: Never allow your spa surface to be exposed to alcohol, acetone (nail polish remover), nail polish, dry cleaning solution, lacquer thinners, gasoline, pine oil, abrasive cleaners, or any other household chemicals other than those listed. These chemicals void the warranty.

Spa Cabinet Care

The EternaWood™ cabinet components are made to provide many years of maintenance-free service. For normal cleaning, use a mild dish-washing soap. For stubborn stains, contact your authorized Bullfrog Spas Dealer.

Spa Cover Care

WARNING: A non-secured, improperly secured, or damaged cover may pose a safety threat to children and may also cause damage or injury if blown off by wind. Always remove entire cover before using the spa.

IMPORTANT: Do not stand, sit, or place any item on the cover that could damage it. Gently remove any snow accumulations over 2 inches (5cm). Always secure the cover with all of the cover locks when not in use, whether the spa is empty or full of water.

Cleaning the Spa Cover

At least monthly, clean the spa cover.

Step 1: Use a garden hose to spray entire cover down with water.

Step 2: Rinse all traces of dirt, sand, and debris from cover.

Step 3: Try not to touch cover or rub anything on it while it is wet.

Step 4: Let cover air dry.

Step 5: Make sure the cover clips are secured.

NOTE: If water doesn't bead on cover when spraying with water and cover looks darker in some areas, use an outdoor fabric protectant (never petroleum based) to condition the area per your Bullfrog Spas Dealer's instructions.

NOTE: If more thorough cleaning is required, add 2 ounces of mild soap to 1 gallon of warm water. Clean the cover fabric with a soft brush. Rinse thoroughly with cold water and air dry. Use an outdoor fabric protectant to condition the area per your Bullfrog Spas Dealer's instructions.

Miscellaneous Care

Cleaning and Protecting Headrests

Regularly clean all headrests with mild soap, water, and a clean cloth. Monthly, treat headrests using a non-petroleum-based conditioning product as recommended by your Bullfrog Spas dealer. This will maintain water resistance and luster of the product.

IMPORTANT: Remove the pillows during and after shock treating the spa water or when sanitizer levels are high. Leave cover open for at least 30 minutes after shocking to ensure pillows are not affected.

NOTE: Pillow discoloration and/or degradation is accelerated by high sanitizer use, improper ventilation after shock treatments, and is not covered by the Bullfrog Spas Warranty.

Vacuum the Spa

Debris from wind, trees, and users will occasionally accumulate on the bottom of the spa. The filtration system will remove the smaller debris. Large or heavy debris can be removed with a hand held spa vacuum available at your Bullfrog Spas dealer.

Low-Use or No-Use Periods

During certain times of the year, you may not use the spa on a frequent basis. For these low-use or no-use periods, consider the following:

No Use for Two to Six Weeks

If the spa will not be used for at least two weeks, lower the temperature to the lowest setting of 80 F (26°C) or place in low range heat mode. Lowering the temperature will cut the cost of operation, however; you will need to adjust the temperature setting approximately 4 hours before use in order to heat the spa to 100 F (38°C).

IMPORTANT: During all low and no-use periods, be sure to maintain the spa water as per the instructions in the Water Chemistry section.

IMPORTANT: For all no-use periods, and on a weekly basis, be sure to have someone visually check that the spa is functioning correctly and to also maintain the spa water as per the instructions under the Water Chemistry section. Not doing so may lead to corrosion, staining, and/or scaling to the spa and its equipment. During periods of freezing temperatures, a spa that has malfunctioned may be subject to damaged plumbing or equipment as a result of ice buildup within the spa. If the spa cannot be checked and maintained on a weekly basis, then consider winterizing the spa.

No Use for Over Six Weeks

When you are not planning to use the spa for six or more weeks, or when someone is not able to maintain the spa on a weekly basis, you should use Away mode. For extended absences you may also choose to winterize the spa. To winterize, follow these steps:

Winterization

WARNING: Prior to winterizing your spa, it will be necessary to super sanitize the spa water as per the instructions in the Water Chemistry section. This procedure will help prevent the growth of bacteria, algae and fungi in any areas of plumbing that may not be fully free of water after you drain your spa for its period of winterization.

NOTE: Your spa is equipped with a freeze protection mode. When potentially freezing outside temperatures are detected your control system will turn on to check the water temperature. If heating is necessary to protect from freeze conditions your spa may turn on and heat to a safe temperature. A notification will display on the main control screen indicating this mode is engaged.

Step 1: Drain the water.

Step 2: If your spa is equipped with JetPaks, open all lower valves to allow the water to drain from each pak as you drain the spa. Once the water is completely out of the spa then close each valve before proceeding to step 3.

Step 3: Use a shop vacuum to vacuum the plumbing lines by placing the vacuum nozzle over each of the lower jet faces in the spa. Lower jets are any jets located at or below the bench seat area.

Step 4: Remove the drain plug from the pump(s) and loosen all PVC pipe unions in the equipment compartment. Do not replace the plugs or tighten the unions until the spa is de-winterized.

Step 5: Clean the spa shell and JetPaks (if equipped).

Step 6: Remove filter cartridge(s), clean, and reinstall.

Step 7: Secure the cover to the spa utilizing the tie downs and locking system. In areas where heavy snow is anticipated, place a large piece of plywood (or its equivalent) on top of the spa cover to assist in supporting the cover with the added weight of the snow. Remove snow off the cover following each snow storm.

WARNING: To avoid water from becoming trapped between the floor suction fitting and the filter pipe. Use a wet/dry vacuum to remove the remaining water out of pipe by placing the vacuum end over the filter hole. In a two-pump spa, first plug off one filter using a tennis ball then vacuum out the water. Or pour ½-1 gallons (5-9 liters) of RV antifreeze into the filter hole.

NOTE: RV antifreeze is nontoxic and does not require evacuation at start up.

Spa De-Winterization

To de-winterize the spa, reverse the winterization procedure. Refill to the water level mark.

WARNING: Whenever refilling the spa, it will be necessary to Super Sanitize the new spa water. Instructions are found in the Water Chemistry section.

LED Light Replacement

Contact your authorized Bullfrog Spas Dealer for repair.

X Series Door Removal

Step 1: Remove trim strips from trim channels by pulling carefully and firmly, working from the bottom of the trim strip to the top. Place trim strips aside.

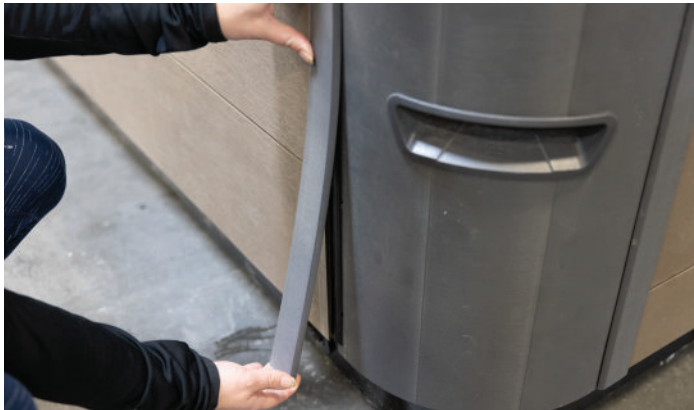

Step 2: Remove door - Carefully pull bottom of door out toward you. Carefully grab the bottom corner of the door and pull it out enough that you can slip your other hand in behind the side of the door about 4-5 inches (10-13 cm) up from the bottom. From there you will pull the door firmly away from the spa until the snap on the door pulls out of the snap feature in the rib. Continue to pull the door away until the second snap on the other side pulls out. The door can then be dropped out of the groove on top and removed from the spa.



Step 3: Electrical Disconnect – be sure to disconnect any lighting or any other electrical wiring that is mounted onto the door before completely removing it.

Step 4: When removed, lean door against spa.

X Series Door Installation

Step 1: Electrical –Reconnect any lighting or electrical devices on the door before installing.

Step 2: Door – Slip the upper lip of the door into the top behind the lip of the spa. Lower the door while gently pushing on it until you feel the snaps line up with the snap features in the ribs. Starting from one side, force the first snap into place and then force the other side until the door is secured.

Step 3: Replace trim strips by snapping each carefully into the trim channel.

X6R Door Removal

Step 1: Remove trim strips from trim channels by pulling carefully and firmly, working from the bottom of the trim strip to the top. Place trim strips aside.

Step 2: Remove door – Pull the bottom of the door forward, the door can then be dropped out of the groove on top and removed from the spa.

Step 3: Electrical Disconnect – be sure to disconnect any lighting or any other electrical wiring that is mounted onto the door before completely removing it.

Step 4: Slip the upper lip of the door behind the lip of the spa. Place door securely against spa flush with the side panels. After the door has been completely removed, lean door against spa.

X6R Door Installation

Step 1: Electrical –Reconnect any lighting or electrical devices on the door before installing.

Step 2: Door – Lower the door while gently pushing on it until you feel the snaps line up with the snap features in the studs. Starting from one side, for the first snap into place and then force the other side until the door is secured.

Step 3: Replace trim strips by snapping each carefully into the trim channel.

INSTALLATION & DELIVERY

Reference Material

Before attempting to install or use your spa, please read Important Safety Instructions as well as all the installation instructions that follow.

Site Selection and Preparation

Your home most likely offers multiple sites where your spa may be installed. Use the information presented in this section to assist you in carefully selecting the site that works best for you. It is your responsibility to choose and prepare the site properly before delivery, so you will experience a smooth and efficient delivery as well as obtain optimal use and full enjoyment of your spa.

Environment:

Surroundings: The direction that your spa will be facing will contribute to your overall bathing experience. Select the spa location that will provide optimal views based on your property layout. Consider your lifestyle and where you want to enjoy your spa and situate it accordingly. Indoor installations provide privacy, but create high levels of humidity (see Indoor Considerations). If your spa is outside, a nearby place for you and your guests to change clothes is a huge convenience. Also, a location near a house entry is convenient in areas with extreme winter climates.

Indoor Considerations: Indoor spa installations have special requirements.

The environment both around and below the spa should be water resistant, and preferably waterproof. It must be capable of handling water splashed out from the spa as well as the possibility of a malfunction.

Recommendations to handle water around the spa include, but are not limited to, a floor drain and/or a catch basin equivalent to the volume of water in your spa. Condensation can also occur on the spa cover and drip onto the floor. Therefore, ensure that flooring materials provide a good grip when wet and are resilient to constant exposure of water and chemicals.

In addition to handling the water from the spa, it is recommended that the room be properly ventilated. Humidity levels will naturally increase after the spa is installed and in use. Water may get into woodwork and produce dry rot, mildew, or other problems. Over time, high levels of humidity and spa chemicals can cause water damage to your floor, wall, and ceiling surfaces.

To minimize humidity damage, it is best to provide plenty of ventilation such as a ceiling fan and moisture-resistant paint. An architect can help to determine if special ventilation equipment is required, such as a humidistat

or dehumidifier which can be installed to regulate indoor humidity during spa use.

NOTE: Typical indoor surfaces include, but are not limited to concrete, wood, non-slip tile, or linoleum.

Outdoor Considerations: There are several considerations when installing your spa outdoors.

1. Avoid selecting a site where excessive water may contact the spa, such as sprinklers or a roof edge without rain gutters.
2. Avoid areas of direct, prolonged sunlight (if possible). The ultraviolet rays may fade or damage the spa cover and cabinet.
3. Check all applicable national and local codes regarding possible restrictions that require fencing or childproof gates around the spa.
4. Prevent dirt, sand, and foliage from being tracked into your spa by utilizing concrete, concrete pavers, or stone for paths and access areas (or, avoid positioning your spa in an area where debris will be tracked into the spa). Check the location of trees and spill paths from gutters to determine if wind or rain will sweep debris into your spa.
5. Consider your view and your privacy during all seasons of the year so your experience in your outdoor spa will be enhanced rather than limited.

NOTE: Typical outdoor surfaces include, but are not limited to concrete, brick, non-slip tile, wood decking, pea gravel, or sand.

Spa Location

Service Access: Some people choose to install tile, stone, or custom wood around their spas. If you are installing your spa with custom trimming, remember to allow access for service. Should your spa need service, a technician may need to remove the spa's equipment compartment door or side panels, or access the spa from beneath. Also, it is always best to design special installations so the spa can still be moved, or lifted from the ground.

Access to Circuit Breakers: For service purposes, allow easy access to the circuit breakers in the electrical service panel (permanently connected models), or to the interrupter switch on the end of the power cord (cord-connected models).

Electrical Safety Requirements: The installation of all spas must be in accordance with national and local wiring rules and with applicable permits consistent with local regulations. A licensed Electrician must perform the electrical installation and GFCI test procedure. Each Bullfrog Spa is manufactured and tested to a standard that provides maximum protection against electrical shock.

Improper wiring may prevent the spa from operating safely which could result in electrical shock, injury, or death. Improper wiring could also lead to a malfunction of the spa's equipment and risk of fire. When considering a location for your spa, consult with a licensed Electrician pertaining to the following:

Overhead Power Lines: Based upon the national and local wiring rules that apply to your area, you will need to install your spa at the required minimum horizontal and vertical distances from all power lines.

Service Disconnect: Based upon your area, a disconnect device must be incorporated into the fixed wiring in accordance with national and local wiring rules. If the national and local wiring rules permit, a GFCI or RCD Sub-Panel may be used to substitute the service disconnect, providing that it is located within the same parameters.

Electrical Outlets, Switches and Devices: Based upon the national and local wiring rules that apply to your area, you must install your spa at the required minimum distance from all electrical outlets, switches, and devices.

Bonding: Based upon the national and local wiring rules that apply to your area, the Control System Box located inside the equipment compartment of your spa must be bonded to all metal equipment, handrails, fixtures, enclosures, pipe, or conduit that are located within the maximum specified distances. The bonding is to be connected to the ground lug connector on the exterior surface of the Control System Box and all metal items previously described.

Equipment Compartment Access: Make sure the spa is positioned so access to the equipment compartment will not be blocked.

All other national and local rules that may be applicable.

Water Drainage: Your spa contains an equipment compartment, which houses all of its electrical components. Allowing water into the equipment compartment can damage the electronics, or may result in tripping your spa's circuit breaker. If installing the spa in a SpaVault, below ground level, or where water may accumulate it is the owner's responsibility to ensure that water will drain adequately so as not to damage spa equipment. For normal installations at ground level choose a site where water will drain away from the spa.

Use of a Cover-Lifting Mechanism: If using a cover-lifting mechanism, allow up to 18 inches (.61m) of clearance behind the spa. Check with your authorized Bullfrog Spas Dealer for the exact clearance requirements for the cover-lifting mechanism.

Spa Foundation

General Guidelines: Select a structurally sound flat surface

that is reasonably level to serve as your spa's foundation. A foundation that shifts or settles may cause stress to the spa shell.

The foundation that your spa rests on must have a weight bearing load capability of supporting the weight of your spa, its water, and the people using it. The maximum filled weight of a spa can be as much as 6,000 lbs. (2,800kg), plus the weight of the occupants that use the spa (for the weight bearing load requirements as well as the maximum filled weight of your spa, refer to the Spa Technical Specifications Chart or contact your local authorized Bullfrog Spas Dealer).

If your spa's pad is slightly sloped it may not affect the performance of the spa or its structure, however, there should be no dips, sags, or unevenness in the pad. Most patios are built to slope away from the house for drainage purposes. There should be no more than a 1/2" (1cm) slope in an 8 ft (2m) run. Recommended flooring materials include a concrete pad, concrete pavers or bricks, pea gravel, or crushed rock 1.5" (4cm) or less, or a reinforced deck. Additionally, your authorized Bullfrog Spas Dealer may sell or recommend pre-formed spa pads.

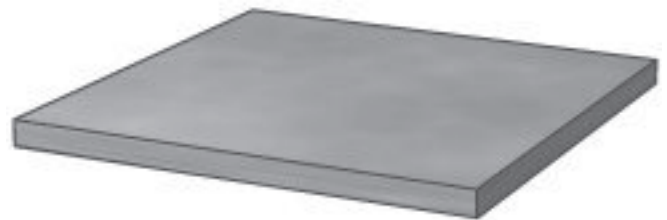

Concrete Pad

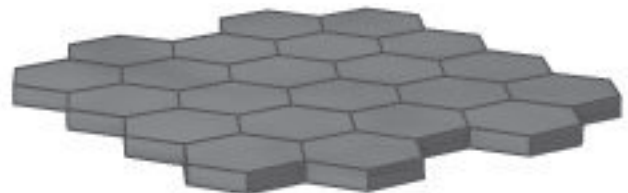

Concrete Pavers



Pea Gravel or Crushed Rock

NOTE: Concrete foundations should be a minimum of 4 inches (10cm) thick and should be reinforced with either rebar or mesh. For electrical grounding purposes, the rebar or mesh should be attached to a bond wire (see Electrical Requirements and Installation Instructions).

WARNING: To prevent serious damage to your spa, it is important that the spa foundation be supported by a flat, stable, and consistent subsurface. Bullfrog Spas International highly recommends consulting a qualified, licensed contractor prior to the installation of any spa foundation. For assistance, contact your authorized Bullfrog Spas Dealer.

WARNING: Because your spa pad must provide continuous support for the entire base of the spa, you should never level it with shims. If it is necessary to level your spa, make sure the entire spa's structure is fully supported, both in the center as well as the outer edge. When leveling your spa, there should be no voids beneath it. Contact your authorized Bullfrog Spas Dealer before making any leveling adjustments. Structural damage to the spa resulting from incorrect installation, placement on an inadequate foundation, or improper leveling will void the spa's warranty.

Elevated Installations: Be certain your deck or elevated structure can support the maximum filled weight of your spa with the total weight of occupants that use it. You must know the deck's weight-bearing load capacity and ensure that it is greater than the maximum filled weight of your spa combined with the occupants using it or serious injury or structural damage could result. To find the weight-bearing load requirement along with the maximum filled weight of your spa, refer to the Spa Technical Specifications Chart or contact an authorized Bullfrog Spas Dealer.

CAUTION: Consult a qualified structural engineer or contractor before the spa is placed on an elevated structure or deck.

Design Considerations

Hard-Surface Options (Decking and Flooring): In addition to selecting a hard surface that meets the recommended safety and maintenance criteria, consider textures and colors that will assist in enhancing the aesthetics of the area in which your spa will be installed. The decision to match, contrast, or blend the hard surface colors and textures with those of your spa should only be made after carefully researching your options. The cost of a Landscape Architect may be money well spent.

Surrounding Landscape: The correct landscape around your spa will not only soften the adjacent hard surface areas, but will add life and much enjoyment to the environment. If the budget allows, you may want to consult with a Landscape Architect for expert advice.

Spa-Side Accessories: Besides selecting the correct hard surfaces and landscape around your spa, the addition of the proper spa-side accessories will provide just the finishing touch that you are looking for. Spa steps, benches, towel racks, planter boxes, or an outdoor fireplace are just a few of the items that can be considered when accessorizing your spa.



Delivery Basics

To prepare for the delivery of your spa, make sure the delivery path is clear and no obstructions are present. Occasionally a crane is required to install the spa by lifting it to its final destination. The crane operator will lift your spa over walls, buildings, or any other obstruction and place it as close to the installation site as possible.

Depending on access to the spa site, your spa may be dollied in either horizontal or vertical position. For your convenience, the following charts provide the dimensions of your spa in either the horizontal or vertical position.

WARNING: An empty spa (spa without water in it) must not be left exposed to sunlight as shell damage may occur. Once the spa is unwrapped, fill spa with water immediately or shade the spa with cover or wrapping to prevent direct exposure to sunlight.

WARNING: Watch for power lines.

Electrical Requirements

New Installations and Re-Installations

These instructions apply to both new installations and re-installations which may occur when a spa is moved or relocated to a new location.

120V~/60Hz Equipment

120V~/60Hz CordConnected Installation: This option is only applicable if the spa was ordered from the factory with both a 120V~/60Hz pump and a 120V~/60Hz power cord. The spa's Safety Approval Listing and warranty will be void, and the spa may be unsafe if an aftermarket power cord is installed on the spa. Cord-Connected spas have already been converted to operate on 120V~/60Hz power at the factory and come with approximately 15' (4.57m) of usable power cord (the maximum length allowed) attached to the spa. This factory installed power cord comes with a built-in GFCI breaker.

IMPORTANT: Cordage shall be replaced only with a special cordage assembly available from the manufacturer, its service agent, or similarly qualified persons in order to avoid a hazard.

Cord-Connected 120V~/60Hz spas require that the factory installed power cord, with its built-in GFCI breaker be connected to a 120V~/60Hz, 15A, Single-Phase, dedicated, grounded circuit and power outlet. It is important that this circuit is dedicated (not being used by any other electrical appliance) or your spa may not function properly. For safety purposes, the location of the power outlet (where the spa is to be connected) can be no closer than the minimum allowable distance specified by the national and local wiring rules in your area. Installation must be in accordance with all national and local wiring rules.

WARNING: Never use an extension cord. Bullfrog International, LC does not allow the use of an extension cord under any possible situation. The use of an extension cord voids any warranty on the spa equipment and also exposes the consumer to additional risk of fire, electrical shock, injury, or death.

120V~/60Hz Equipment

Permanently-Connected 120V~/60Hz spas require a GFCI protected, 3-wire (Line 1, Neutral and Ground), 120V~/60Hz, 15A, Single-Phase,dedicated electrical circuit. It is important that this circuit is dedicated (not being used by any other electrical appliance) or the spa may not function properly. Installation must be in accordance with all national and local wiring rules.

240V~/60Hz Equipment

Permanently-Connected 240V~/60Hz spas require a GFCI protected, 4-wire (Line 1, Line 2, Neutral, and Ground), 240V~/60Hz, 50A or 60A, Single-Phase, dedicated electrical circuit. It is important that this circuit is dedicated (not being used by any other electrical appliance) or the spa may not function properly. Spa models with 3 jet pumps (M9, M8, and A9L) require a 60A service for full functionality. Installation must be in accordance with all national and local wiring rules

230V~/50Hz Equipment

This equipment allows for the spas to operate only on a 230V~/50 Hz electrical service.

Permanently-Connected 230V~/50Hz, 32A spas require an RCD protected, 230V~50Hz, 32A Single-Service, or 16A Single Service, or 16A-16A x2, 400V~,3N, 50Hz, 16Ax3, dedicated electrical circuit. It is important that this circuit is dedicated (not being used by any other electrical appliance)or the spa may not function properly. For specific conversion instruction, please refer to the system wiring diagram inside the Control System Box (located in the spa's equipment compartment). Installation must be in accordance with all national and local wiring rules.

New Installations and Re-Installations

These instructions apply to both new installations and re-installations which may occur when a spa is moved or relocated to a new location.

120V~/60Hz Equipment

120V~/60Hz Cord-Connected Installation: This option is only applicable if the spa was ordered from the factory with both a 120V~/60Hz pump and a 120V~/60Hz power cord. The spa's Safety Approval Listing and warranty will be void, and the spa may be unsafe if an aftermarket power cord is installed on the spa. Cord-Connected spas have already been converted to operate on 120V~/60Hz power at the factory and come with approximately 15' (4.57m) of usable power cord (the maximum length allowed) attached to the spa. This factory installed power cord comes with a built-in GFCI breaker.

IMPORTANT: Cordage shall be replaced only with a special cordage assembly available from the manufacturer, its service agent, or similarly qualified persons in order to avoid a hazard.

Cord-Connected 120V~/60Hz spas require that the factory installed power cord, with its built-in GFCI breaker be connected to a 120V~/60Hz, 15A, Single-Phase, dedicated, grounded circuit and power outlet. It is important that this circuit is dedicated (not being used by any other electrical appliance) or your spa may not function properly. For safety purposes, the location of the power outlet (where the spa is to be connected) can be no closer than the minimum allowable distance specified by the national and local wiring rules in your area. Installation must be in accordance with all national and local wiring rules.

WARNING: Never use an extension cord. Bullfrog International, LC does not allow the use of an extension cord under any possible situation. The use of an extension cord voids any warranty on the spa equipment and also exposes the consumer to additional risk of fire, electrical shock, injury, or death.

120V~/60Hz Equipment

Permanently-Connected 120V~/60Hz spas require a GFCI protected, 3-wire (Line 1, Neutral and Ground), 120V~/60Hz, 15A, Single-Phase, dedicated electrical circuit. It is important that this circuit is dedicated (not being used by any other electrical appliance) or the spa may not function properly. Installation must be in accordance with all national and local wiring rules.

240V~/60Hz Equipment

Permanently-Connected 240V~/60Hz spas require a GFCI protected, 4-wire (Line 1, Line 2, Neutral, and Ground), 240V~/60Hz, 50A or 60A, Single-Phase, dedicated electrical circuit. It is important that this circuit is dedicated (not being used by any other electrical appliance) or the spa may not function properly. Spa models with 3 jet pumps (M9, M8, and A9L) require a 60A service for full functionality. Installation must be in accordance with all national and local wiring rules.

230V~/50Hz Equipment

This equipment allows for the spas to operate only on a 230V~/50 Hz electrical service.

Permanently-Connected 230V~/50Hz, 32A spas require an RCD protected, 230V~50Hz, 32A Single-Service, or 16A Single Service, or 16A-16A x2, 400V~,3N, 50Hz, 16Ax3, dedicated electrical circuit. It is important that this circuit is dedicated (not being used by any other electrical appliance) or the spa may not function properly. For specific conversion instruction, please refer to the system wiring diagram inside the Control System Box (located in the spa's equipment compartment). Installation must be in accordance with all national and local wiring rules.

Connecting the electrical service to the spa

IMPORTANT: Installation must be in accordance with all national and local wiring rules and performed by a licensed Electrician.

Step 1: Choose one of the three available conduit entry points. (Yellow Black decal)

Step 2: Determine the conduit diameter and drill a hole that is properly sized for the conduit ($\frac{3}{4}$ " conduit drill 1-1/8" hole, 1" conduit drill 1-3/8" hole). Use the + as the locator for the center of the hole. The hole saw must go through two layers of plastic. There is a 1" space between both layers.

Step 3: Push the conduit through the hole until it comes out into the equipment area

Step 4: Remove the faceplate to the Control System Box

Step 5: Connect the conduit to the Control System Box using a Liquid Tight Connector.

Step 6: Run the required wires through the conduit to the Control System Box.

Step 7: Connect the electrical service wires to the terminal block located in the Control System Box.

Step 8: Replace the Control System Box faceplate and the equipment compartment door. The electrical hook-up is complete.

Note: To conform with electrical codes, and to create a barrier against pests, any holes created in the base of your Bullfrog Spa should be fitted with an appropriate connector.

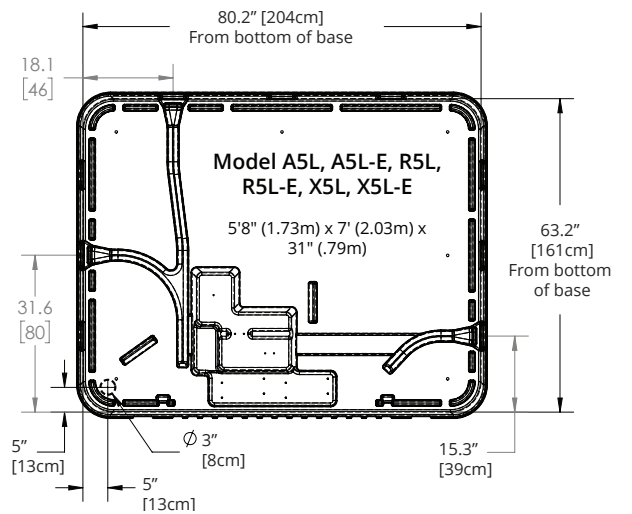
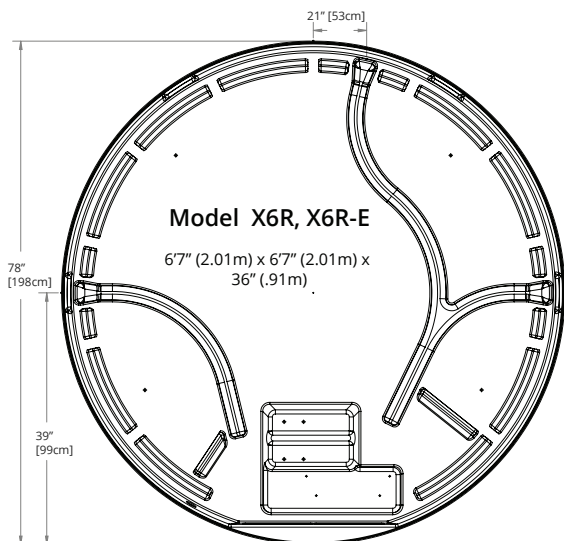
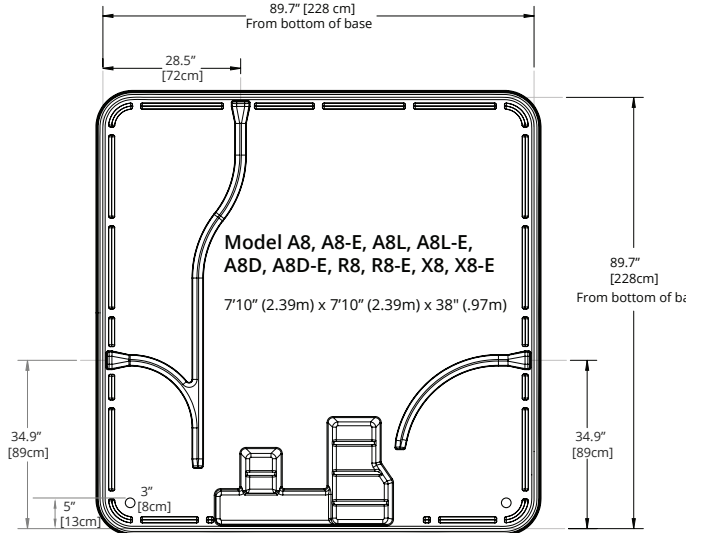
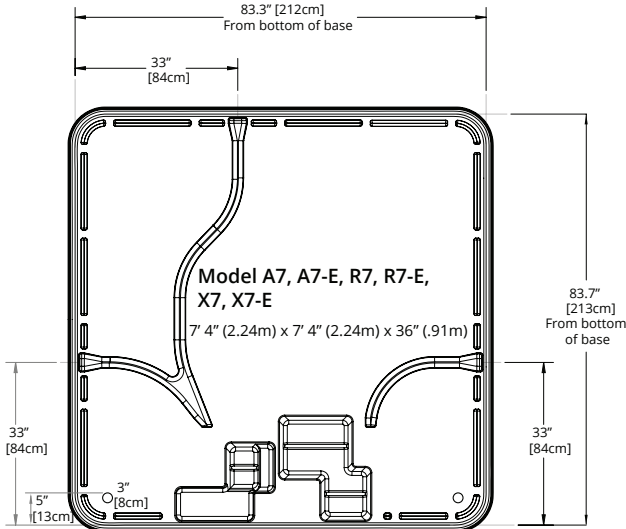
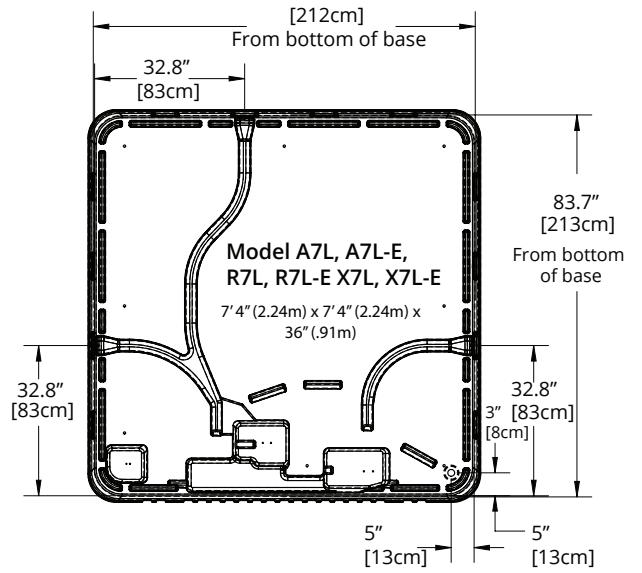
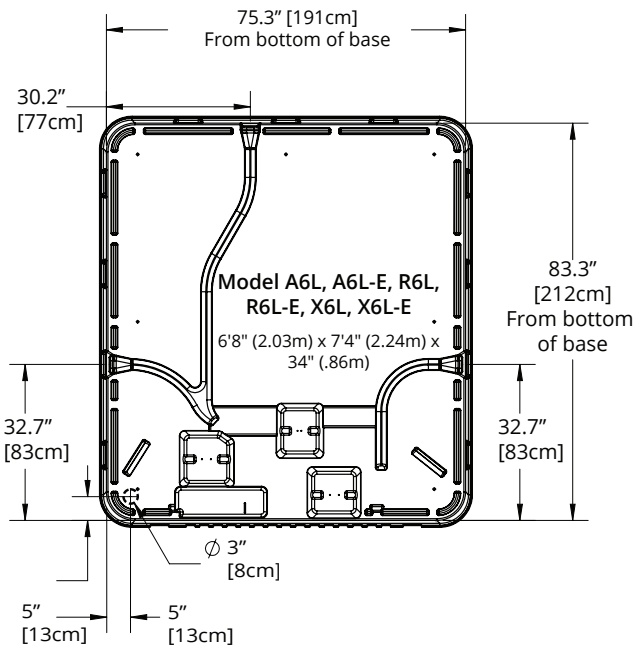

SETUP AND WIRING DIAGRAMS

Hardware Setup/Wiring Diagram X Series (yt 6)

Connecting high voltage accessories: North American model in.yt

For the connection to the 0.250 inch terminals, the high voltage accessories must be provided with female quick connect terminals, straight and non-insulated for all types of connections, including the ground. Accessories of 120 V or 240 V may be connected to the corresponding terminals of the printed circuit of the in.yt. Refer to the following tables for correct connections. Note that all female terminals must be correctly and completely seated on the printed circuit terminals for proper current ratings.

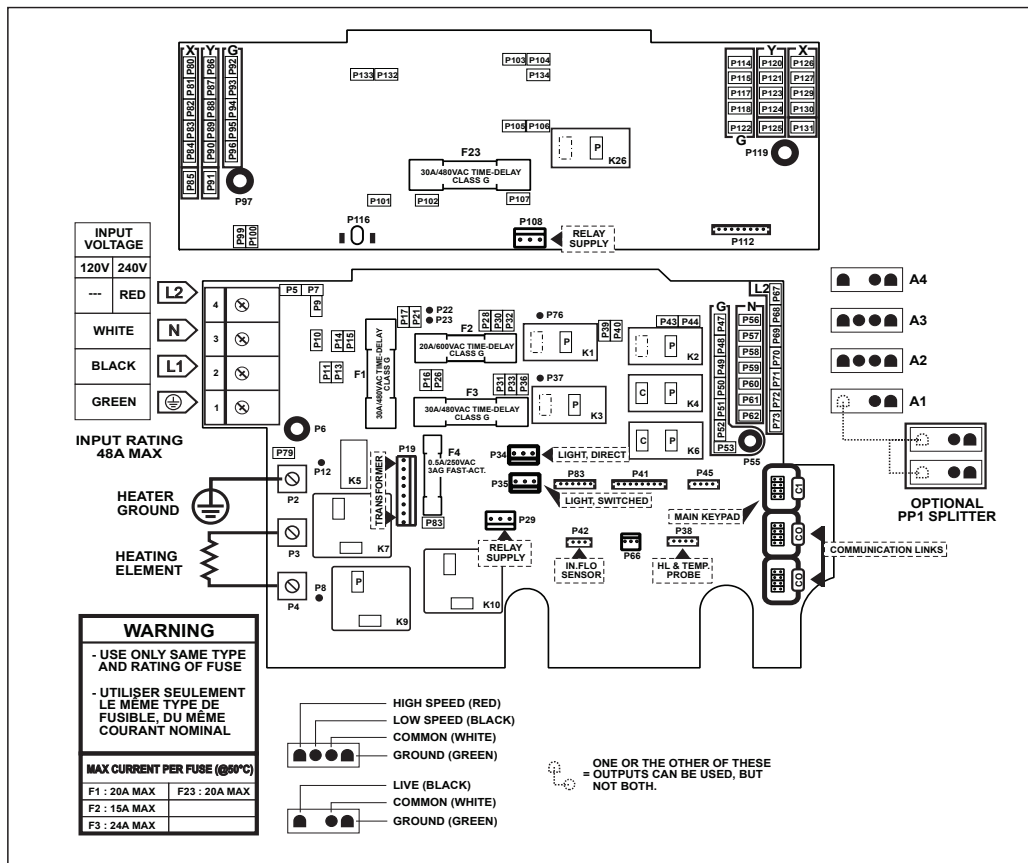

Pump 1 (A2)

Voltage	240 V
Green / ground	G
Black / low speed	K6
Red / high speed	K3
White / common	L2

Pump 2 (A3)

Voltage	240 V
Green / ground	G
Black / low speed	K4
Red / high speed	K2
White / common	L2

Circulation pump (A1)

Voltage	240 V
Green / ground	G
Black / line	K1
White / common	L2

Ozonator (A4)

Voltage	240 V
Green / ground	G
Black / line	K26
White / common	L2

Hardware Setup/Wiring Diagram X Series, 50Hz Equipment (yt6) v3

Connecting high voltage accessories: European model in.yt

For the connection to the 0.250 inch (6mm) terminals, the high voltage accessories must be provided with female quick connect terminals, straight and non-insulated for all types of connections, including the ground. Only 230 V accessories may be connected to the corresponding terminals of the printed circuit of the in.yt. Refer to the following tables for correct connections. Note that all female terminals must be correctly and completely seated on the printed circuit terminals for proper current ratings.

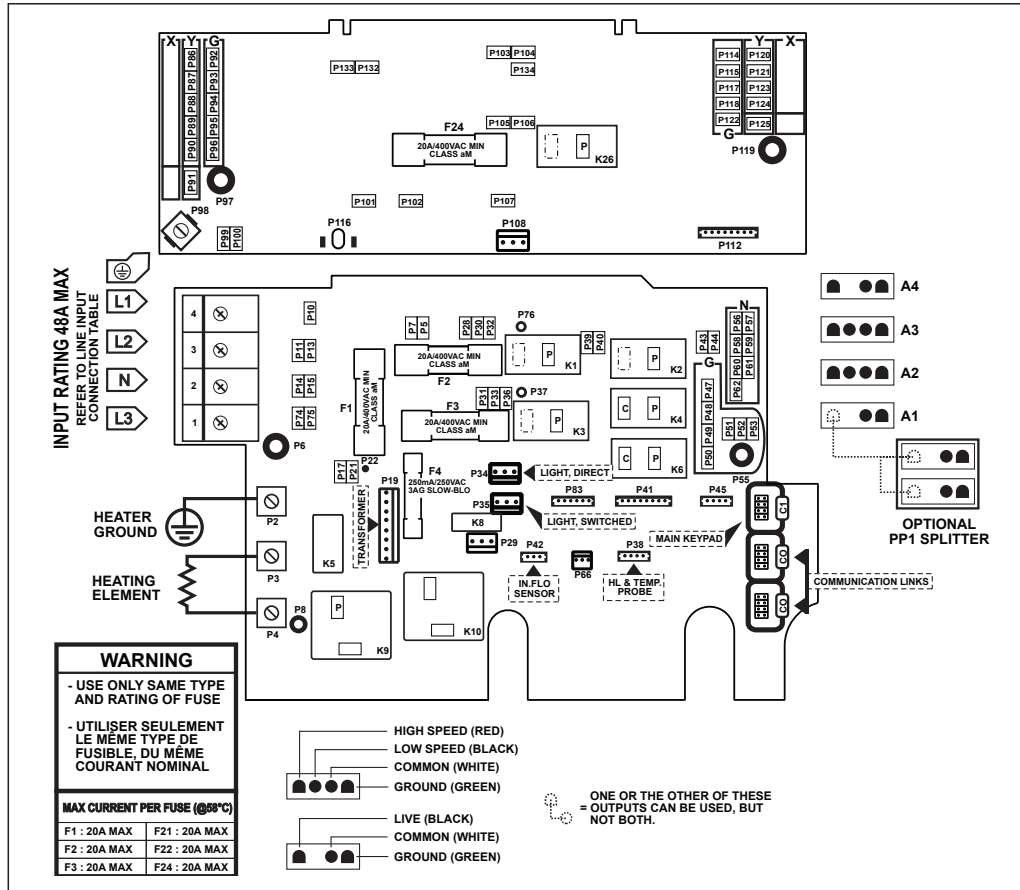

Pump 1 (A2)		Pump 2 (A3)		Circulation pump (A1)		Ozonator (A4)	
Voltage	230 V	Voltage	230 V	Voltage	230 V	Voltage	230 V
Green / ground	G	Green / ground	G	Green / ground	G	Green / ground	G
Black / low speed	K6	Black / low speed	K2	Black / line	K4	Black / line	K26
Red / high speed	K3	Red / high speed	K1	White / common	N	White / common	N
White / common	N	White / common	N				

Light (12 V AC, 1A Max.)

Always on	P34
Relay	P35

Hardware Setup/Wiring Diagram X Series, 60Hz Equipment YE 6 Box

WARNING / AVERTISSEMENT

USE ONLY #14 AWG TO #12 AWG COPPER CONDUCTORS. NOT FOR USE WITH COMPACT STRAND WIRE.

UTILISER SEULEMENT DES CONDUCTEURS EN CUIVRE #14 AWG À #12 AWG. NE PAS UTILISER DE FIL À TORSIONS COMPACTES.

WARNING / AVERTISSEMENT

PERMANENTLY CONNECTED SPAS NEED A DISCONNECTING MEANS LOCATED WITHIN SIGHT OF THE EQUIPMENT AND AT LEAST 6 ft (1.82 m) FROM THE INSIDE WALL OF THE SPA.

LES SPAS CONNECTÉS DE MANIÈRE PERMANENTE ONT BESOIN D'UN DISPOSITIF DE DÉCONNEXION QUI SE TROUVE À PORTÉE DE VUE DE L'ÉQUIPEMENT ET À AU MOINS 6 PIEDS (1,82 M) DE LA PAROI INTÉRIEURE DU SPA.

ONLY USE SAME TYPE OF FUSE / WITH SAME CURRENT RATING. MAX. CURRENT PER FUSE / COURANT MAX. PAR FUSIBLE (80°C)

UTILISER SEULEMENT DES FUSIBLES DE MÊME TYPE AVEC LA MÊME SPÉCIFICATION DE COURANT.

F1: 15A MAX F3: 20A MAX
F2: 15A MAX F3: 15A MAX

GECKO
IN-YE-6-AMP-V3
17518-01D

ONE OR THE OTHER OF THESE OUTPUTS CAN BE USED, BUT NOT BOTH.

L'UNE OU L'AUTRE DE CES SORTIES PEUT ÊTRE UTILISÉE, MAIS PAS LES DEUX.

HIGH SPEED (RED)
LOW SPEED (BLACK)
COMMON (WHITE)
GROUND (GREEN)

LIVE (BLACK)
COMMON (WHITE)
GROUND (GREEN)

WARNING

FOR PROPER GROUNDING, GREEN WIRES MUST BE CONNECTED TO A GROUND TERMINAL ON THE PCB.

250V ACCESSORIES: ALL OUTPUTS MAY BE CONFIGURED AS 120V BY PLUGGING THE WHITE WIRES TO ANY GROUND TERMINAL ON THE PCB.

240V ACCESSORIES: ALL OUTPUTS MAY BE CONFIGURED AS 240V BY PLUGGING THE WHITE WIRES TO ANY L2 TERMINAL ON THE PCB.

AVERTISSEMENT

POUR LA MISE À LA TERRE, LES FILS VERTS DOIVENT ÊTRE CONNECTÉS À UN CONNECTEUR DE LA CARTE ÉLECTRONIQUE.

ACCESSOIRES 250V: TOUTES LES SORTIES SONT CONFIGURABLES 120V EN CONNECTANT LES FILS BLANCS À N'IMPORTE QUEL CONNECTEUR DE LA CARTE ÉLECTRONIQUE.

ACCESSOIRES 240V: TOUTES LES SORTIES SONT CONFIGURABLES 240V EN CONNECTANT LES FILS BLANCS À N'IMPORTE QUEL CONNECTEUR L2 DE LA CARTE ÉLECTRONIQUE.

TECHNICAL DOCUMENTS / DOCUMENTS TECHNIQUES

MODEL / MODÈLE: _____

OPTIONS: _____

INPUT / ENTRÉE: _____

ID NUMBER / NO. PRODUIT: _____

MADE IN MEXICO

YE 6 North America (Top) YE 6 Europe (Bottom)

WARNING / AVERTISSEMENT

USE ONLY #14 AWG TO #12 AWG COPPER CONDUCTORS. NOT FOR USE WITH COMPACT STRAND WIRE.

UTILISER SEULEMENT DES CONDUCTEURS EN CUIVRE #14 AWG À #12 AWG. NE PAS UTILISER DE FIL À TORSIONS COMPACTES.

WARNING / AVERTISSEMENT

PERMANENTLY CONNECTED SPAS NEED A DISCONNECTING MEANS LOCATED WITHIN SIGHT OF THE EQUIPMENT AND AT LEAST 6 ft (1.82 m) FROM THE INSIDE WALL OF THE SPA.

LES SPAS CONNECTÉS DE MANIÈRE PERMANENTE ONT BESOIN D'UN DISPOSITIF DE DÉCONNEXION QUI SE TROUVE À PORTÉE DE VUE DE L'ÉQUIPEMENT ET À AU MOINS 6 PIEDS (1,82 M) DE LA PAROI INTÉRIEURE DU SPA.

ONLY USE SAME TYPE OF FUSE / WITH SAME CURRENT RATING. MAX. CURRENT PER FUSE / COURANT MAX. PAR FUSIBLE

UTILISER SEULEMENT DES FUSIBLES DE MÊME TYPE AVEC LA MÊME SPÉCIFICATION DE COURANT.

F1: 20A MAX F3: 20A MAX
F2: 20A MAX F3: 20A MAX

GECKO
IN-YE-6-AMP-CE-V3
17518-01B

ONE OR THE OTHER OF THESE OUTPUTS CAN BE USED, BUT NOT BOTH.

L'UNE OU L'AUTRE DE CES SORTIES PEUT ÊTRE UTILISÉE, MAIS PAS LES DEUX.

HIGH SPEED (RED)
LOW SPEED (BLACK)
COMMON (WHITE)
GROUND (GREEN)

LIVE (BLACK)
COMMON (WHITE)
GROUND (GREEN)

WARNING

FOR PROPER GROUNDING, GREEN WIRES MUST BE CONNECTED TO A GROUND TERMINAL ON THE PCB.

250V ACCESSORIES: PLUG THE WHITE ACCESSORIES WIRE TO ANY L1 TERMINAL ON THE PCB.

MAX AMBIENT TEMPERATURE: 80°C
48°C FOR SINGLE-PHASE CONFIGURATIONS WHERE INPUT CURRENT EXCEEDS 32A (8A MAX).

AVERTISSEMENT

POUR LA MISE À LA TERRE, LES FILS VERTS DOIVENT ÊTRE CONNECTÉS À UN CONNECTEUR DE LA CARTE ÉLECTRONIQUE.

ACCESSOIRES 250V: CONNECTER LE FIL BLANC DES ACCESSOIRES À N'IMPORTE QUEL CONNECTEUR L1 DE LA CARTE ÉLECTRONIQUE.

TEMPÉRATURE AMBIANTE MAX: 80°C
48°C POUR LES CONFIGURATIONS MONOPHASEES OU LE COURANT D'ENTRÉE EXCÈDE 32A (8A MAX).

TECHNICAL DOCUMENTS / DOCUMENTS TECHNIQUES

MODEL / MODÈLE: _____

OPTIONS: _____

INPUT / ENTRÉE: _____

ID NUMBER / NO. PRODUIT: _____

MADE IN MEXICO

D	ADDED QR CODE	AUG 22	M FR
C	ADJUSTMENTS FOR PRINTING	JUN 20	K T
B	TORQUE INFORMATION REMOVED	JUL 20	K T
A	ORIGINAL	JUN 20	P L
NO	REVISION	DATE	INS APPR
		FILE NO.	17518-01D
		LOGIC	COREL/DRAW 12
		PRINT DATE:	AUG 02, 2022
		CONDUIT:	
		DATE:	
		DESIGNED BY: P. LESSARD	
		DATE: JUN 08, 2020	
		VERIFIED BY:	
		DATE:	
		APPROVED BY:	
		DATE:	
ÉCHELLE	1"=1"	NUMERO DE PIÈCE	POUR FIN DE
			FUSILLE
			1 DE 1

B	ADDED QR CODE	AUG 22	M FR
A	ORIGINAL	JUN 20	P L
NO	REVISION	DATE	INS APPR
		FILE NO.	17518-01B
		LOGIC	COREL/DRAW 12
		PRINT DATE:	AUG 02, 2022
		CONDUIT:	
		DATE:	
		DESIGNED BY: P. LESSARD	
		DATE: JUN 08, 2020	
		VERIFIED BY:	
		DATE:	
		APPROVED BY:	
		DATE:	
ÉCHELLE	1"=1"	NUMERO DE PIÈCE	POUR FIN DE
			FUSILLE
			1 DE 1

GFCI WIRING DIAGRAMS

Electrical wiring: North American model in.ye and in.yt

Refer to wiring diagram in the enclosure box lid for more information.

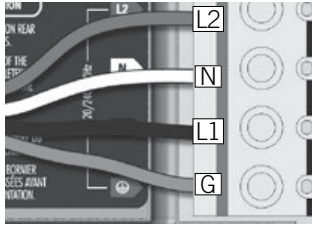

240 V (4 wires)

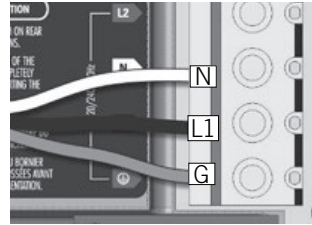

120 V (*3 wires)

* If connected to a 3 wires system, the heat.wave and accessories will not operate at 240 V.

Note: To convert model to a 120 V system, the white (common) accessory wire must be moved. See wiring diagram for details.

Refer to the section
« Connections for 120 V
heaters ».

Insert each wire into the appropriate socket of the main entry terminal block according to the color code indicated on the sticker. Use a flat-head screwdriver to tighten the screws on the terminal.

After making sure wires are securely connected, push them back into the box and replace the cover. Do not over tighten cover screws (torque to 8 in. lb max {0.9 N.m}).

Connect the bonding conductor to the bonding lug on the front of the spa pack (a grounded electrode conductor should be used to connect the equipment grounding conductors).

RCD WIRING DIAGRAMS

Electrical wiring: European model in.yt

Refer to wiring diagram in the enclosure box lid for more information.



Warning

in.yt.ce models must always be connected to a circuit protected by a Residual-Current Device (RCD) having a rated operating residual-current not exceeding 30 mA. Correct wiring of the electrical service box, RCD, and pack terminal block is essential! Check your electrical code for local regulations. Only copper wire should be used, never aluminum.

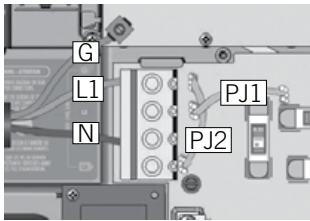

1-phase

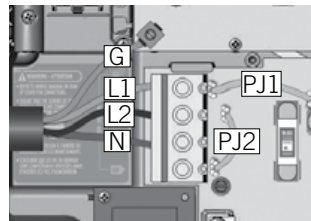

2-phase

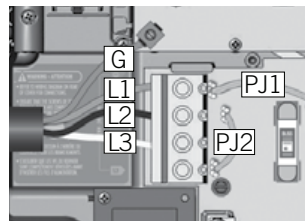

3-phase Delta (no neutral)

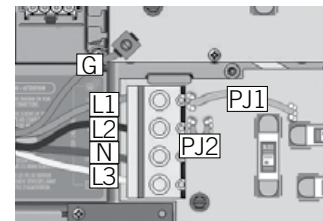

3-phase with single neutral

Connect PJ1 between P7 and P13.

Connect PJ1 between P7 and P10.

Connect PJ1 between P7 and P10.

Connect PJ1 between P7 and P10.

Connect PJ2 between P10 and P74.

Connect PJ2 between P13 and P74.

Connect PJ2 between P13 and P74.

Connect PJ2 between P11 and P13.

Insert each wire into the appropriate socket of the main entry terminal block according to the color code indicated on the sticker. Use a flat-head screwdriver to tighten the screws on the terminal.

After making sure wires are securely connected, push them back into the box and replace the cover. Do not over tighten cover screws (torque to 8 in. lb max {0.9 N.m}).

Connect the bonding conductor to the bonding lug on the front of the spa pack (a grounded electrode conductor should be used to connect the equipment grounding conductors).

TROUBLESHOOTING GUIDE

This guide will assist in solving simple problems with the spa. If the problem cannot be solved using these procedures, contact your authorized Bullfrog Spas Dealer.

Control panel displays an error message:

Cause: An error has occurred.

Solution: See Diagnostic Messages for specific errors.

Control pad and spa equipment do not operate:

Cause #1: No electrical power to spa.

Solution: Turn on or reset the GFCI circuit breaker. If this does not solve the problem, have a qualified Electrician check the electrical service.

Cause #2: The 20 or 30A fuse, depending on the system, has blown.

Solution: Contact your authorized Bullfrog Spas Dealer.

GFCI breaker trips repeatedly:

Cause #1: Improper wiring to spa or GFCI breaker is defective.

Solution: Consult with a qualified Electrician.

Cause #2: There is a defective component on the spa.

Solution: Contact your authorized Bullfrog Spas Dealer.

Spa pump turns off during operation:

Cause #1: Automatic timer has completed its 30 or 60 minute cycle.

Solution: Turn on the pump.

Cause #2: Pump has overheated due to the vents on the equipment door being blocked.

Solution: Clear items away from vents.

Cause #3: The pump motor is defective.

Solution: Contact your authorized Bullfrog Spas Dealer.

Spa will not heat:

Cause #1: Thermostat has been turned down or set to low heat range.

Solution: Adjust thermostat to desired temperature or set to high heat range.

Cause #2: High limit sensor has tripped.

Solution: Press any button to reset.

Cause #3: Heating system is defective.

Solution: Contact your authorized Bullfrog Spas Dealer.

Standard Spa light does not work:

Cause #1: Light bulb has burned out.

Solution: Replace light bulb.

Cause #2: Lighting system is defective.

Solution: Contact your authorized Bullfrog Spas Dealer.

Jets surge on and off:

Cause: Water level is too low or filters may be dirty.

Solution: Adjust water to the water level indication mark on the faceplate of the filter assembly. Clean the filters.

Spa pump will not turn on, creates a burning smell while running, or makes excessive noise while running:

Cause: Pump motor is defective. Running during high ambient outside temperatures, excessive run time.

Solution: Contact your authorized Bullfrog Spas Dealer.

Jets are weaker than normal or do not work at all, but the pump is running:

Cause #1: Jet handle(s) X Series are partially or fully closed. Valves are closed Series A & R JetPak II, Solution: Open jet handle(s) / valve(s).

Cause #2: Filter cartridge is dirty. Solution: See Cleaning the Filter.

Cause #3: There is air trapped in the spa equipment or its face piping.

Solution: Remove the clamp to the air bleed line and remove the air line from the pump until air has purged out and you see water flow and reconnect.

Cause #4: The suction fitting(s) are blocked.

Solution: Remove any debris that may be blocking the suction fitting(s).

If your issue is not listed here, contact your dealer for further instructions.

WARRANTY INFORMATION



LIMITED WARRANTY

X Series

Bullfrog International, LC ("Bullfrog") extends warranty coverage solely to the original end-user purchaser ("Owner") of any X Series Bullfrog Spa installed for residential use in the United States or Canada.

3 year Warranty

Shell Surface

- Bullfrog warrants the surface finish of the Bullfrog Spa not to crack, wrinkle, blister, peel or delaminate for three years from the original spa purchase date.

Plumbing

- Bullfrog warrants the jet fittings, internal plumbing, drains and hoses not to leak for three years from the original spa purchase date.

Cabinet

- Bullfrog warrants the cabinet corners, door and side panels against degradation and cracking for three years from the original spa purchase date. Surface stains and fading are not covered under the terms of this warranty.

Equipment

- Warranty specifically covers the pump(s), heater, control system (including fuses), Filter-Cap™, other Bullfrog mechanical equipment.
- Defective components that are easily removed from the spa and that can be readily replaced by the customer and do not require specialized tools or knowledge or create personal safety issues, all of which are deemed easily removed components, will be repaired or replaced free of charge at your authorized Bullfrog Spa Dealer or by sending the defective component(s) to Bullfrog. This warranty excludes audio systems, water care systems, and the interior and exterior spa lighting systems.

Patio Performance™ Spa Cover

- Bullfrog warrants the Patio Performance spa cover against defects in materials or workmanship for 3 years from the original spa purchase date.

3 year Warranty

Spas

- Year 1: 100% component replacement and labor coverage.
- Year 2: 100% component replacement and labor coverage.
- Year 3: 100% component replacement and labor coverage.

5 year Warranty

Frame

- Bullfrog warrants the injection-molded spa frame against degradation for five years from the original purchase date of the spa.

Shell Structure

- Bullfrog warrants the Bullfrog Spa shell not to leak for five years from the original spa purchase date.

1 year Warranty

Lighting Systems

- Bullfrog warrants the spa lighting systems against defects in materials and workmanship for one year from the original spa purchase date. Defective components that are easily removed from the spa which are deemed easily removed components, will be repaired or replaced free of charge at your authorized Bullfrog Spa Dealer or by sending the defective component(s) to Bullfrog.

Audio System

- Bullfrog warrants audio systems against defects in materials and workmanship for one year from the original spa purchase date.

Water Care Systems

- Bullfrog warrants water care systems against defects in materials and workmanship for one year from the original spa purchase date.

OTHER WARRANTIES

Bullfrog warrants the Bullfrog Spa pillows, stainless steel jet faces, and filter(s) against defects in materials and workmanship through time of delivery.

Warranty Performance

Bullfrog or its authorized agent will repair or replace any malfunction or defective component on the Bullfrog Spa that is covered under the terms of this limited warranty and was purchased from an authorized Bullfrog spa dealer.

In doing so, Bullfrog reserves the right, at its option, to either repair or replace the defective spa or component.

If Bullfrog determines that the repair of the defect is not feasible, we reserve the right to instead provide a replacement spa or component equal in value to the original purchase price of the defective spa or original value of the component. In such an event costs for removal of the defective spa, shipping costs of the replacement product and delivery will be the responsibility of the spa owner. Bullfrog reserves the right to use either new or reconditioned replacement components. In some situations, the servicing dealer may charge a reasonable travel mileage fee. Any repair or replacement shall provide no new warranty coverage, but shall retain only the remaining portion of the original product's warranty.

To obtain warranty service, contact your authorized Bullfrog Spa Dealer or Bullfrog and submit proof of purchase. Any defective spa or component sent directly to the factory for warranty repair must be pre-authorized by Bullfrog and must be freight prepaid. Return freight will be paid by Bullfrog on all warranted components and spas, excluding any spa returned that is more than seven years after its purchase date. If the entire spa is sent to the factory for repair, all costs of removing and re-installing the spa at spa owner's location will be the responsibility of the spa owner. Repair or replacement, as described above, shall be Bullfrog's sole liability for any breach

Exclusions

This Bullfrog Spa limited warranty is void if any of the following occur:

- The spa has been subject to alteration, neglect, misuse or abuse.
- Any repairs are attempted by anyone other than an authorized agent of Bullfrog.
- The spa has been used in a non-residential application or in an application for which it was not designed.
- Damage is caused by an Act of God or any other cause beyond the control of Bullfrog.
- Damage is caused by the addition or use of any non-approved mechanical or electrical component, or chemical substance.
- Damage is caused by shipping, moving, mishandling, improper installation or electrical hook-up by someone other than Bullfrog.
- Damage to the spa shell is caused by excessive heat build-up due to failure to cover spa while empty of water and/or exposed to direct sunlight.
- Damage is caused by operating the spa outside the water temperature range of 32°F-120°F (0°C-49°C).
- Damage is caused by improper maintenance of spa water chemistry or by allowing undissolved spa chemicals to lie on the spa's surface.
- Damage is caused by failure to install, maintain and operate the spa in accordance with the recommendations contained in the Bullfrog Owner's Manual, Pre-Delivery Guide or any other printed instructions, notice or bulletin from Bullfrog.

Limitations

THIS LIMITED WARRANTY TAKES THE PLACE OF ALL OTHER WARRANTIES, EXPRESS OR IMPLIED, IN FACT OR AT LAW, INCLUDING IMPLIED WARRANTIES OF MERCHANTABILITY AND FITNESS FOR A PARTICULAR PURPOSE. ALL WARRANTY SERVICE MUST BE PERFORMED BY BULLFROG OR ITS AUTHORIZED AGENT. NO AGENT, DEALER, DISTRIBUTOR, SERVICE COMPANY OR OTHER PARTY IS AUTHORIZED TO CHANGE, MODIFY OR EXTEND THE TERMS OF THIS LIMITED WARRANTY IN ANY MANNER WHATSOEVER.

Disclaimers

BULLFROG AND ITS AUTHORIZED AGENTS SHALL NOT BE LIABLE FOR ANY INJURY, LOSS, COST OR OTHER DAMAGE, WHETHER INCIDENTAL, CONSEQUENTIAL, SPECIAL OR PUNITIVE, ARISING OUT OF ANY DEFECT COVERED BY THIS LIMITED WARRANTY, INCLUDING WITHOUT LIMITATION, LOSS OF USE OF THE SPA AND COST FOR REMOVAL OF DEFECTIVE PRODUCT, EVEN IF BULLFROG HAS BEEN ADVISED OF THE POSSIBILITY OF SUCH DAMAGE. THE LIABILITY OF BULLFROG UNDER THIS LIMITED WARRANTY, IF ANY, SHALL NOT EXCEED THE ORIGINAL AMOUNT PAID FOR THE DEFECTIVE PRODUCT. COVERAGE UNDER THIS LIMITED WARRANTY SHALL COMMENCE AS OF THE ORIGINAL DATE OF PURCHASE AND THE DURATION OF SUCH COVERAGE SHALL NOT EXTEND FOR ANY REASON WHATSOEVER BEYOND THE STATED TIME PERIOD. THESE DISCLAIMERS SHALL BE EQUALLY APPLICABLE TO ANY SERVICE PROVIDED BY BULLFROG OR ITS AUTHORIZED AGENTS.

Legal Rights

This Limited Warranty gives you specific legal rights. You may also have other rights which vary from state to state. Some states do not allow limitations on how long an implied warranty lasts, so this limitation may not apply to you. Prompt registration of your warranty helps protect your warranty rights.

Updated 1/2022

U.S. Patents: 5,754,989, 5,987,663, 6,000,073, 6,092,246, 6,256,805, 6,543,067.

Additional patents pending.

New Zealand Patent: 334,093.

Canada Patent: 2,260,237

Other patents pending: 12 additional countries.

7017 West 11800 South • Herriman, Utah 84096

Tel (801) 565-8111 • Fax (801) 565-8333

www.bullfrogspas.com • info@bullfrogspas.com



Bullfrog International, LC
7017 W 11800 S
Herriman, UT 84096
T: 801.565.8111
F: 801.565.8333
E: info@bullfrogspas.com

v 1

Register your spa online by visiting:
bullfrogspas.com/warranty-registration

North America 2023
Bullfrog International LC